

Circuitor

AC Ammeter

DCB-48 Aac



INSTRUCTION MANUAL

(M213B01-03-19A)



SAFETY PRECAUTIONS

Follow the warnings described in this manual with the symbols shown below.

	<p>DANGER Warns of a risk, which could result in personal injury or material damage.</p>
---	---

	<p>ATTENTION Indicates that special attention should be paid to a specific point.</p>
---	--

If you must handle the unit for its installation, start-up or maintenance, the following should be taken into consideration:

	<p>Incorrect handling or installation of the unit may result in injury to personnel as well as damage to the unit. In particular, handling with voltages applied may result in electric shock, which may cause death or serious injury to personnel. Defective installation or maintenance may also lead to the risk of fire. Read the manual carefully prior to connecting the unit. Follow all installation and maintenance instructions throughout the unit's working life. Pay special attention to the installation standards of the National Electrical Code.</p>
---	---

	<p>Refer to the instruction manual before using the unit In this manual, if the instructions marked with this symbol are not respected or carried out correctly, it can result in injury or damage to the unit and /or installations.</p>
---	--

CIRCUTOR, SA reserves the right to modify features or the product manual without prior notification.

DISCLAIMER

CIRCUTOR, SA reserves the right to make modifications to the device or the unit specifications set out in this instruction manual without prior notice.

CIRCUTOR, SA on its web site, supplies its customers with the latest versions of the device specifications and the most updated manuals.

www.circutor.com



CONTENTS

SAFETY PRECAUTIONS	3
DISCLAIMER	3
CONTENTS	4
REVISION LOG	5
SYMBOLS	5
1.- VERIFICATION UPON RECEPTION	6
2.- PRODUCT DESCRIPTION	6
3.- DEVICE INSTALLATION	7
3.1.- PRIOR RECOMMENDATIONS	7
3.2.- INSTALLATION	8
3.3.- DEVICE TERMINALS	9
3.4.- CONNECTION DIAGRAM	9
4.- OPERATION	10
4.1.- DISPLAY	10
4.2.- KEYBOARD FUNCTIONS	10
4.3.- DISPLAY	11
5.- CONFIGURATION	12
5.1.- CONFIGURATION OF THE INPUT	14
5.1.1.- PRIMARY CURRENT	15
5.1.2.- UNITS OF THE PRIMARY CURRENT	15
5.1.3.- SECONDARY CURRENT	16
5.1.4.- UNITS OF THE SECONDARY CURRENT	16
5.1.5.- SAVE CONFIGURATION	16
5.2.- CONFIGURATION OF THE DISPLAY	17
5.2.1.- PASSWORD OFF ACCESS	17
5.2.2.- BRIGHTNESS OF THE DISPLAY	18
5.2.3.- LIGHT ALARM	18
5.2.4.- SAVE CONFIGURATION	19
5.3.- SOFTWARE VERSION	19
6.- TECHNICAL FEATURES	20
7.- MAINTENANCE AND TECHNICAL SERVICE	22
8.- GUARANTEE	22
9.- CE CERTIFICATE	23
ANNEX A.- CONFIGURATION MENU	26
A.1.- DCB-48 Aac	26





REVISION LOG

Table 1: Revision log.

Date	Revision	Description
06/18	M213B01-03-18A	Initial Version
12/18	M213B01-03-18B	Change in the following sections: 3.3. - 3.4. - 9. - Annex A
04/19	M213B01-03-19A	Change in the following sections: 2. - Annex A

SYMBOLS

Table 2: Symbols.

Symbol	Description
	In compliance with the relevant European directive.
	Device covered by European directive 2012/19/EC. At the end of its useful life, do not leave the unit in a household waste container. Follow local regulations on electronic equipment recycling.
	DC current
	AC current

Note : Devices images are for illustrative purposes only and may differ from the actual device.

1.- VERIFICATION UPON RECEPTION

Check the following points when you receive the device:

- The device meets the specifications described in your order.
- The device has not suffered any damage during transport.
- Perform an external visual inspection of the device prior to switching it on.
- Check that it has been delivered with the following:

- An installation guide,



If any problem is noticed upon reception, immediately contact the transport company and/or **CIRCUTOR's** after-sales service.

2.- PRODUCT DESCRIPTION

The **DCB-48 Aac** is a device designed to measure and display the current and frequency AC single-phase.

The device has 2 programmable current scales: 1 A and 5 A.



The device features:

- **4 keys** that allow you to browse between the various screens and program the device.
- **LED display**, displays all parameters,

Table 3:DCB-48 Aac list of models.

Model	Power Supply		
	80 ... 270 V ~	80 ... 270 V ===	18 ... 36 V ===
M22150	✓	✓	-
M221500030000	-	-	✓

3.- DEVICE INSTALLATION

3.1.- PRIOR RECOMMENDATIONS



In order to use the device safely, it is critical that individuals who handle it follow the safety measures set out in the standards of the country where it is being used, use the necessary personal protective equipment, and pay attention to the various warnings indicated in this instruction manual.

The **DCB-48 Aac** device must be installed by authorised and qualified staff.

The power supply plug must be disconnected and measuring systems switched off before handling, altering the connections or replacing the device. It is dangerous to handle the device while it is powered.

Also, it is critical to keep the cables in perfect condition in order to avoid accidents, personal injury and damage to installations.

The device's functionality is limited to the category of measuring voltage or specific current values.

The manufacturer of the device is not responsible for any damage resulting from failure by the user or installer to heed the warnings and/or recommendations set out in this manual, nor for damage resulting from the use of non-original products or accessories or those made by other manufacturers.

If an anomaly or malfunction is detected in the device, do not use it to take any measurements.



Disconnect the device from the power supply (device and measuring system power supply) before maintaining, repairing or handling the device's connections. Please contact the after-sales service if you suspect that there is an operational fault in the device.

3.2.- INSTALLATION



Terminals, opening covers or removing elements can expose parts that are hazardous to the touch while the device is powered. Do not use the device until it is fully installed.

The device should be installed inside an electric panel or enclosure, and panel-mounted.

To install it, take the following steps:

1.- Make a cut in the panel, according to the dimensions in **Figure 1**.

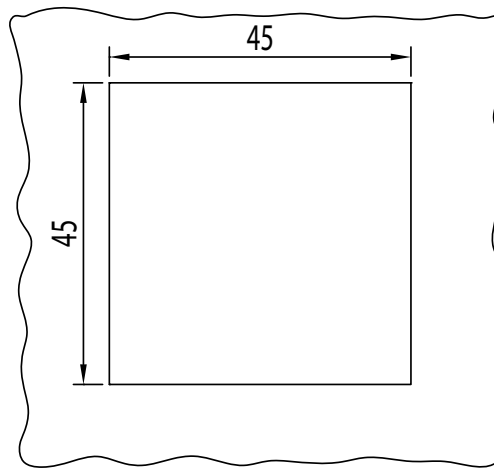

Figure 1: Cut in the panel.

2.- Remove the device's mounting frame (**Figure 2**).

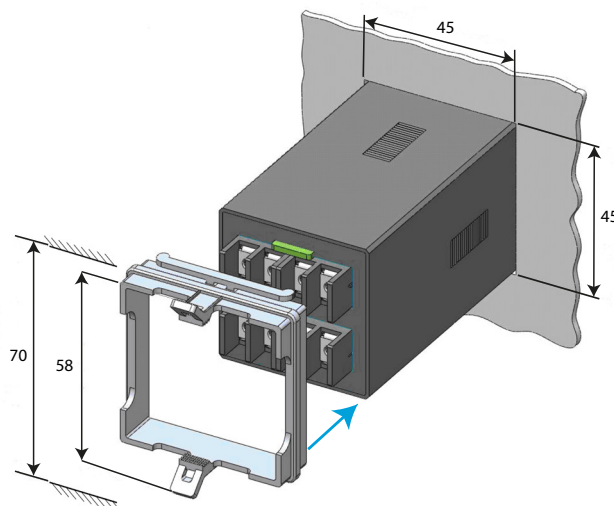

Figure 2: Installation.

3.- Insert the device into the cut in the panel.

4.- Fit the mounting frame until the device is fixed to the panel.

The device should be connected to a power circuit protected by a fuse with a maximum nominal current of **0.25 A**.

3.3.- DEVICE TERMINALS

Table 4:List of terminals of the DCB-48 Aac.

Device terminals	
1 : L, Auxiliary power supply.	4: Current measurement input
2: N, Auxiliary power supply.	5: Current measurement input

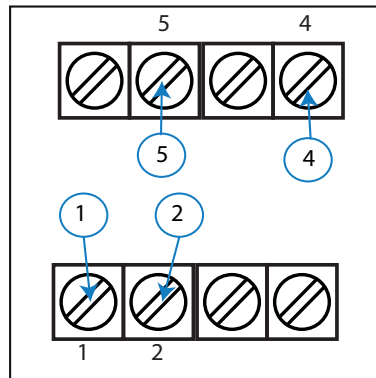

Figure 3:Terminals of the DCB-48 Aac.

Note: Before disconnecting the current measurement connection cables, make sure that you disconnect the transformer's primary cable and bridge the secondary.

3.4.- CONNECTION DIAGRAM

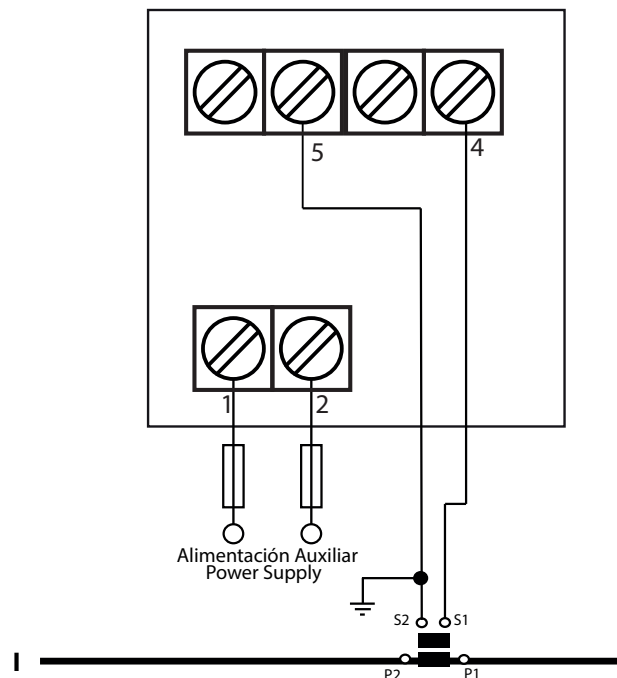

Figure 4: Current measurement DCB-48 Aac.

If the current being measured is higher than the nominal input current, **5A**, a current transformer should be connected to the device.

If more than one device is connected to the current transformer, it is necessary to connect them in series.

4.- OPERATION

4.1.- DISPLAY

The device features a 4-digit LED display, which is used to display the measured parameters and to configure these parameters

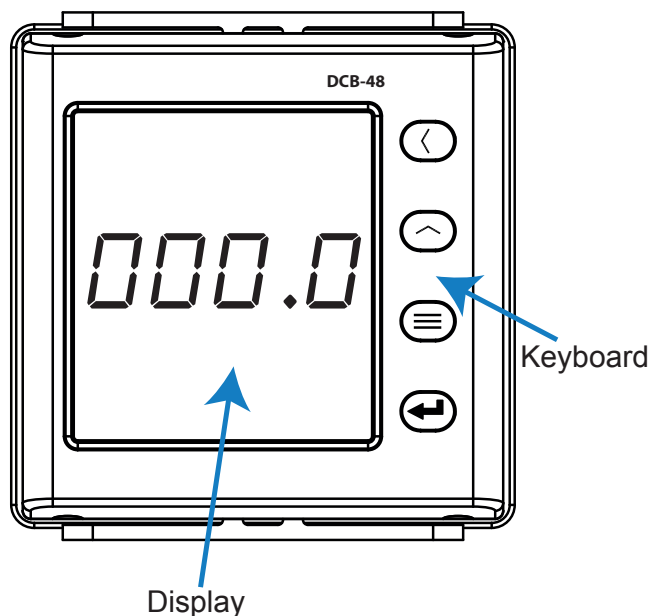





Figure 5: Display DCB-48.

4.2.- KEYBOARD FUNCTIONS

The **DCB-48 Aac** features 4 keys to display and configure the device, **Figure 5**.

Table 5: Keyboard functions.

Key	Keystroke
	Previous screen In the configuration menu: Scroll through the digits
	Next screen In the configuration menu: Increase the value of the digit
	Long keystroke (> 3s): Enter in configuration menu
	In the configuration menu: Jump to the next level / Confirm an operation

4.3.- DISPLAY

The **DCB-48 Aac** features 2 display screens, **Table 6**.

Use the  and  keys to browse the screens.

Table 6: Display menu.

Display menu	
5.000	
Current	
	F 50.0
Frequency	

If the current value measured by the device is higher than a % of the nominal value, the device can make the digits on the display start flashing, in the form of a light alarm. See **“5.2.3.- LIGHT ALARM”**

5.- CONFIGURATION

Press and hold the  key for more than 3 seconds to enter the configuration menu of the device.

The configuration of the device is organized in different menus, **Figure 6**.

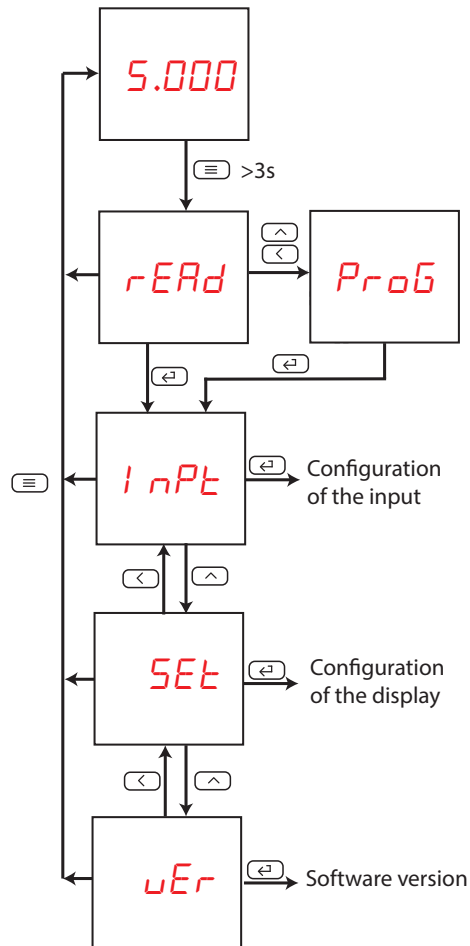





Figure 6: Configuration menu of the DCB-48 Aac.

From any screen of the configuration menus, if no key is pressed for 4 minutes, the device leaves the configuration menu and returns to the display screen.

On the *rEAd* screen, press the , key to access the configuration menu in the **display mode**, i.e., the configuration parameters cannot be modified.

On the *rEAd* screen, press the  or , keys to access the configuration menu in the **programming mode**, i.e., the configuration parameters can be modified.

Note: In “ANNEX A.- CONFIGURATION MENU” you can see the complete configuration menu.

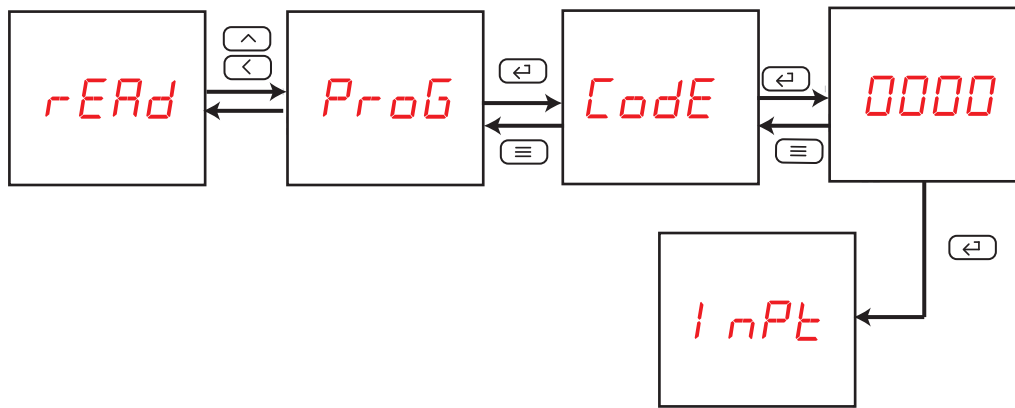

Figure 7: Access the configuration menu in the programming mode.

Before accessing the configuration menu, it is necessary to enter the access password.

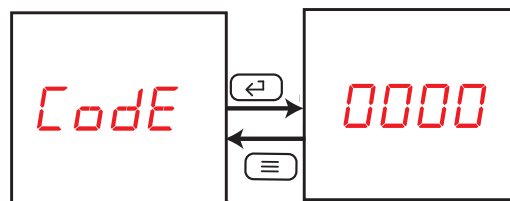





Figure 8: Access password.

Use the  key to modify the value of the flashing digit
When the desired value is shown on the screen, press the  key to skip the digit.

Default password: 0001

Note : *The password can be modified, see “5.2.1.- PASSWORD OF ACCESS”.*

To validate the data, press the  key.

If the password entered is incorrect, the *Err* message will appear for a few seconds and the device will return to the password configuration screen, **Figure 8**.

5.1.- CONFIGURATION OF THE INPUT

Figure 9, shows the main screen of the input configuration menu, from which the primary current and secondary current are configured.



Figure 9: Input configuration menu, main screen.

Press the  key to open the configuration menu.

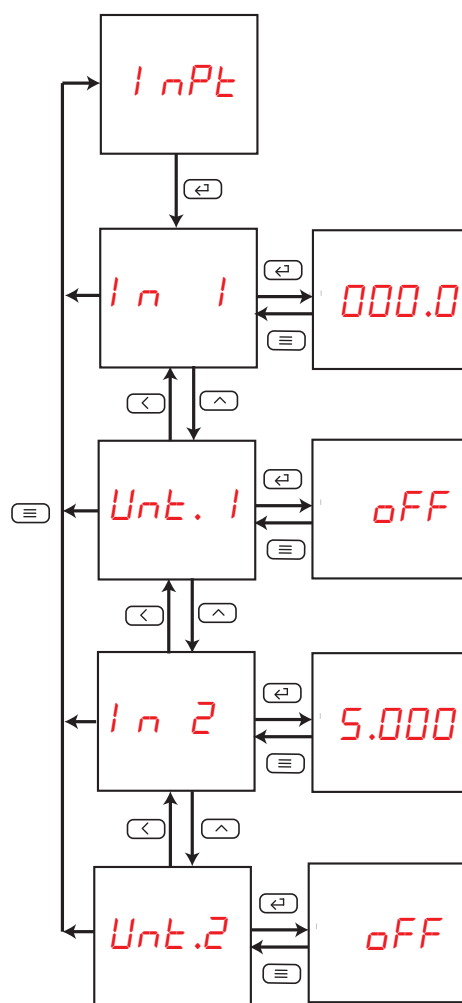
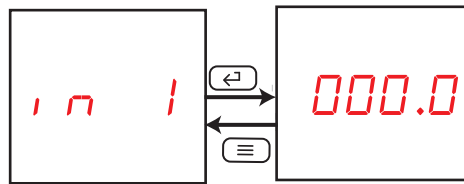

Figure 10: Input configuration menu.

5.1.1.- PRIMARY CURRENT

This screen is used to configure the value of the primary current.



Use the \uparrow key to modify the value of the flashing digit

When the desired value is shown on the screen, press the \leftarrow key to skip the digit.

When you reach the last digit and press the \leftarrow key, you select the position of the decimal point. Use the \uparrow to modify the decimal point.

Minimum configuration value: 1.000.

Maximum configuration value: 9999.

To validate the data, press the \leftarrow key.

Use the \leftarrow and \uparrow keys to browse the configuration screens of the menu.

5.1.2.- UNITS OF THE PRIMARY CURRENT

This screen is used to configure the units of the primary current.

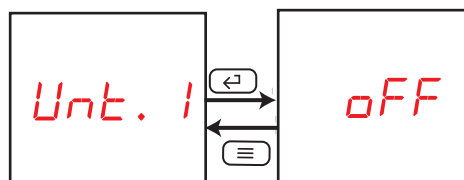

Use the \uparrow key to browse the different options:

oFF , the unit of the primary current is **A**.

on , the unit of the primary current is **kA**.



To validate the data, press the \leftarrow key.

Use the \leftarrow and \uparrow keys to browse the configuration screens of the menu.

5.1.3.- SECONDARY CURRENT

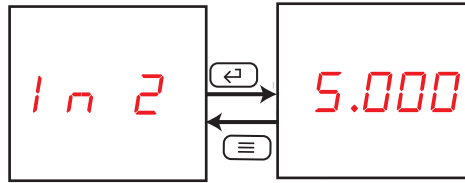
This screen is used to configure the value of the secondary current.





Use the  and  keys at the same time to configure the value.

Use the  key to browse the different options:

5.000, for the current scale of 0 ... 5 A.

1.000, for the current scale of 0 ... 1 A.



To validate the data, press the  key.

Use the  and  keys to browse the configuration screens of the menu.

5.1.4.- UNITS OF THE SECONDARY CURRENT

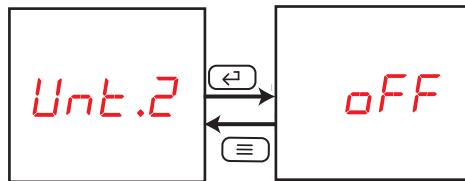
Note: This parameter cannot be modified.



Use the  and  keys to browse the configuration screens of the menu.

5.1.5.- SAVE CONFIGURATION

To save the configuration of the device, press the  key, until the main screen of the input configuration menu is opened, **Figure 9**.

Press the  key again to show the validation screen.

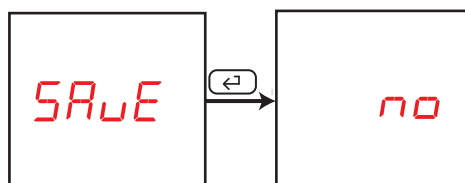

Use the  key to browse the different options:

no, exit the configuration without saving the changed values.

YES, save the changed configuration values.

Press the  key to validate the data and exit the configuration menu.

5.2.- CONFIGURATION OF THE DISPLAY

Figure 11, shows the main screen of the configuration menu of the display.

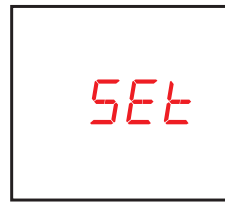

Figure 11: Configuration menu of the display, main screen.

Press the  key to open the configuration menu.

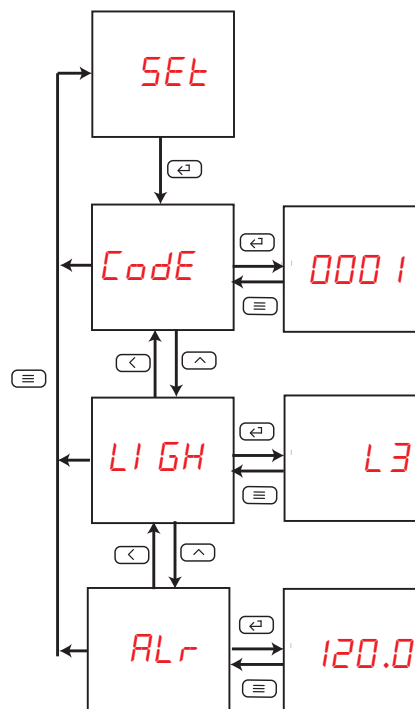
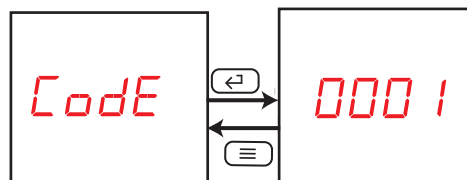



Figure 12: Configuration menu of the display.

5.2.1.- PASSWORD OFF ACCESS

This screen is used to configure the value of the password used to access the configuration menu in the **programming mode**.





Use the  key to modify the value of the flashing digit

When the desired value is shown on the screen, press the  key to skip the digit.

Minimum configuration value: 0

Maximum configuration value: 9999

To validate the data, press the  key.

Use the  and  keys to browse the configuration screens of the menu.

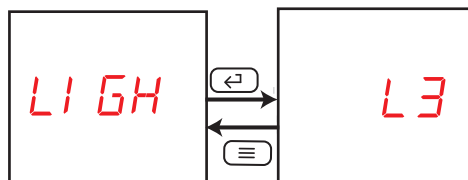

5.2.2.- BRIGHTNESS OF THE DISPLAY

The brightness of the display is configured on this screen.



Use the  key to browse the different options: the display has 5 brightness levels, from $L1$ to $L5$.

To validate the data, press the  key.

Use the  and  keys to browse the configuration screens of the menu.

5.2.3.- LIGHT ALARM

If the current value measured by the device is higher than a % of the nominal value, the device can make the digits on the display start flashing, in the form of a light alarm.

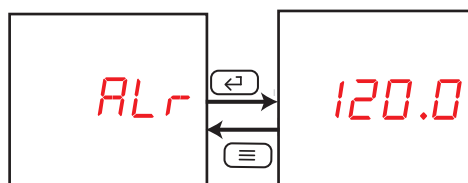

Use the  key to modify the value of the flashing digit.



When the desired value is shown on the screen, press the  key to skip the digit.

Minimum configuration value: 30.3%

Maximum configuration value: 120.0%

Note: If the a value of 0 is programmed, the light alarm will be deactivated.

To validate the data, press the  key.

Use the  and  keys to browse the configuration screens of the menu.

5.2.4.- SAVE CONFIGURATION

To save the configuration of the device, press the  key until the main screen of the configuration menu of the display is opened, **Figure 11**.

Press the  key again to show the validation screen.

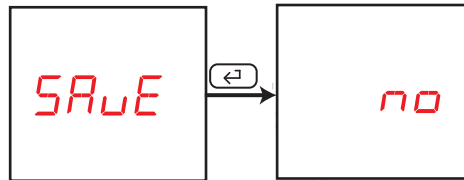

Use the  key to browse the different options:

no, exit the configuration without saving the changed values.

YES, save the changed configuration values.

Press the  key to validate the data and exit the configuration menu.

5.3.- SOFTWARE VERSION

The software version of the device is shown in the **display mode**.

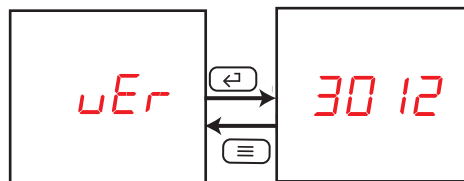

6.- TECHNICAL FEATURES

AC Power supply ⁽¹⁾	
Rated voltage	80 ... 270 V ~
Frequency	50 / 60 Hz
Consumption	0.5 ... 3 VA
Installation category	CAT III 300 V

DC Power supply ⁽¹⁾		
Rated voltage	80 ... 270 V ==	18 ... 36 V ==
Consumption	0.3 ... 0.4 W	
Installation category	CAT III 300 V	

⁽¹⁾ Depending on model :

Model	Power supply		
	80 ... 270 V ~	80 ... 270 V ==	18 ... 24 V ==
M22150	✓	✓	-
M221500030000	-	-	✓

Current measurement circuit	
Nominal current (I _n)	1 A ~ / 5 A ~
Frequency measurement margin	45 ... 65 Hz
Overload	1.2 I _n continuous, 10 I _n Instantaneous (5s)
Consumption	< 0.2 VA
Impedance	< 20 mΩ
Installation category	CAT III 300V

Measurement accuracy	
Current measurement	0.5%

User interface	
Display	LED 4 digits
Keyboard	4 keys

Environmental features	
Operating temperature	-40°C ... +70°C
Storage temperature	-40°C ... +85°C
Relative humidity	≤ 95%
Maximum altitude	2000 m
Protection degree	Front : IP54, Rear case: IP20
Pollution degree	2

Mechanical features	
Dimensions	Figure 13 (mm)
Weight	108 g.
Surround	pc + abs

Standards	
Electromagnetic compatibility (EMC) -- Part 4-2: Testing and measurement techniques - Electrostatic discharge immunity test.	IEC 61000-4-2
Electromagnetic compatibility (EMC)- Part 4-3: Testing and measurement techniques- Radiated, radio-frequency, electromagnetic field immunity test	IEC 61000-4-3

(Continuation) Standards	
Electromagnetic compatibility (EMC) - Part 4-4: Testing and measurement techniques - Electrical fast transient/burst immunity test	IEC 61000-4-4
Electromagnetic compatibility (EMC) - Part 4-5: Testing and measurement techniques - Surge immunity test	IEC 61000-4-5
Electromagnetic compatibility (EMC) - Part 4-6: Testing and measurement techniques - Immunity to conducted disturbances, induced by radio-frequency fields	IEC 61000-4-6
Electromagnetic compatibility (EMC) -- Part 4-8: Testing and measurement techniques - Power frequency magnetic field immunity test	IEC 61000-4-8
Electromagnetic compatibility (EMC) -- Part 4-11: Testing and measurement techniques - Voltage dips, short interruptions and voltage variations immunity tests	IEC 61000-4-11
Safety requirements for electrical equipment for measurement, control and laboratory use -- Part 1: General requirements	IEC 61010-1

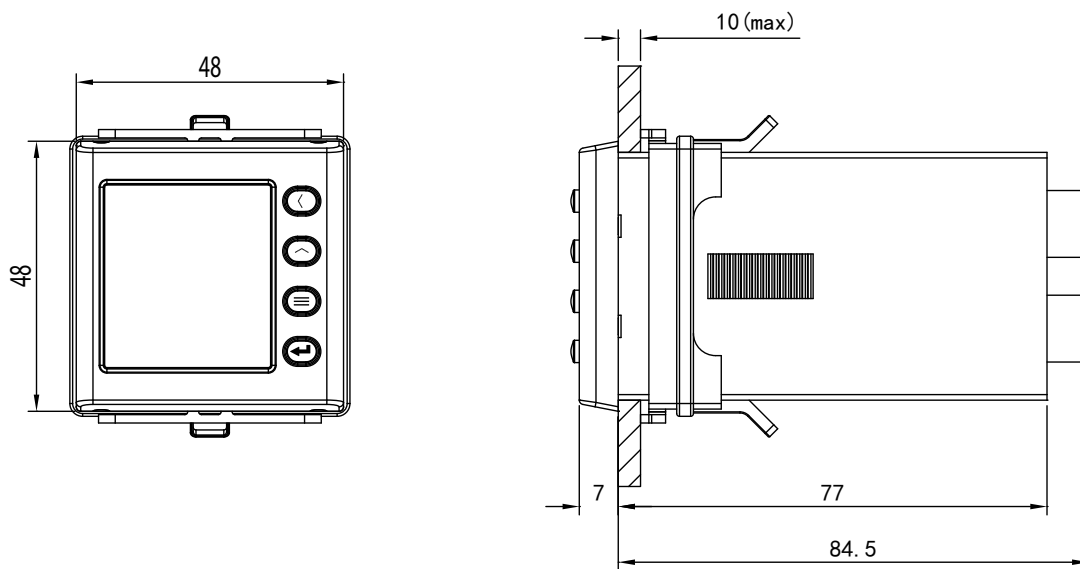

Figure 13: Dimensions of the DCB-48 Aac.

7.- MAINTENANCE AND TECHNICAL SERVICE

In the case of any query in relation to unit operation or malfunction, please contact the **CIRCUTOR, SA** Technical Support Service.

Technical Assistance Service

Vial Sant Jordi, s/n, 08232 - Viladecavalls (Barcelona)

Tel: 902 449 459 (España) / +34 937 452 919 (outside of Spain)

email: sat@circutor.es

8.- GUARANTEE

CIRCUTOR guarantees its products against any manufacturing defect for two years after the delivery of the units.

CIRCUTOR will repair or replace any defective factory product returned during the guarantee period.



- No returns will be accepted and no unit will be repaired or replaced if it is not accompanied by a report indicating the defect detected or the reason for the return.
- The guarantee will be void if the units has been improperly used or the storage, installation and maintenance instructions listed in this manual have not been followed. "Improper usage" is defined as any operating or storage condition contrary to the national electrical code or that surpasses the limits indicated in the technical and environmental features of this manual.
- **CIRCUTOR** accepts no liability due to the possible damage to the unit or other parts of the installation, nor will it cover any possible sanctions derived from a possible failure, improper installation or "improper usage" of the unit. Consequently, this guarantee does not apply to failures occurring in the following cases:
 - Overvoltages and/or electrical disturbances in the supply;
 - Water, if the product does not have the appropriate IP classification;
 - Poor ventilation and/or excessive temperatures;
 - Improper installation and/or lack of maintenance;
 - Buyer repairs or modifications without the manufacturer's authorisation.

9.- CE CERTIFICATE



DECLARACIÓN UE DE CONFORMIDAD

La presente declaración de conformidad se expide bajo la exclusiva responsabilidad de CIRCUTOR con dirección en Vial Sant Jordi, s/n – 08232 Viladecavalls (Barcelona) España

Producto:

Instrumentación digital

Serie:

DCB-48, DCB-72

Marca:

CIRCUTOR

El objeto de la declaración es conforme con la legislación de armonización pertinente en la UE, siempre que sea instalado, mantenido y usado en la aplicación para la que ha sido fabricado, de acuerdo con las normas de instalación aplicables y las instrucciones del fabricante

2014/35/UE: Low Voltage Directive 2014/30/UE: Electromagnetic Compatibility Directive
2011/65/UE: RoHS2 Directive

Está en conformidad con la(s) siguiente(s) norma(s) u otro(s) documento(s) normativos(s):

IEC 61010-1:2010+AMD1:2016 CSV Ed.3.0 IEC 61000-6-2:2016 Ed. 3.0
IEC 61000-6-4:2006+AMD1:2010 CSV Ed.2.1

Año de marcado "CE":

2018



EU DECLARATION OF CONFORMITY

This declaration of conformity is issued under the sole responsibility of CIRCUTOR with registered address at Vial Sant Jordi, s/n – 08232 Viladecavalls (Barcelona) Spain

Product:

Digital Instruments

Series:

DCB-48, DCB-72

Brand:

CIRCUTOR

The object of the declaration is in conformity with the relevant EU harmonisation legislation, provided that it is installed, maintained and used for the application for which it was manufactured, in accordance with the applicable installation standards and the manufacturer's instructions

2014/35/UE: Low Voltage Directive 2014/30/UE: Electromagnetic Compatibility Directive
2011/65/UE: RoHS2 Directive

It is in conformity with the following standard(s) or other regulatory document(s):

IEC 61010-1:2010+AMD1:2016 CSV Ed.3.0 IEC 61000-6-2:2016 Ed. 3.0
IEC 61000-6-4:2006+AMD1:2010 CSV Ed.2.1

Year of CE mark:

2018



DÉCLARATION UE DE CONFORMITÉ

La présente déclaration de conformité est délivrée sous la responsabilité exclusive de CIRCUTOR dont l'adresse postale est Vial Sant Jordi, s/n – 08232 Viladecavalls (Barcelona) Espagne

Produit:

Instrumentation numérique

Série:

DCB-48, DCB-72

Marque:

CIRCUTOR

L'objet de la déclaration est conforme à la législation d'harmonisation pertinente dans l'UE, à condition d'avoir été installé, entretenu et utilisé dans l'application pour laquelle il a été fabriqué, conformément aux normes d'installation applicables et aux instructions du fabricant

2014/35/UE: Low Voltage Directive 2014/30/UE: Electromagnetic Compatibility Directive
2011/65/UE: RoHS2 Directive

Il est en conformité avec la(les) suivante(s) norme(s) ou autre(s) document(s) réglementaire(s):

IEC 61010-1:2010+AMD1:2016 CSV Ed.3.0 IEC 61000-6-2:2016 Ed. 3.0
IEC 61000-6-4:2006+AMD1:2010 CSV Ed.2.1

Année de marquage « CE »:

2018



Viladecavalls (Spain), 16/05/2018
General Manager: Ferran Gil Torné



KONFORMITÄTSERKLÄRUNG UE

Vorliegende Konformitätserklärung wird unter alleiniger Verantwortung von CIRCUTOR mit der Anschrift, Vial Sant Jordi, s/n – 08232 Viladecavalls (Barcelona) Spanien, ausgestellt

Produkt:

Digitale Messgeräte

Serie:

DCB-48, DCB-72

Marke:

CIRCUTOR

Der Gegenstand der Konformitätserklärung ist konform mit der geltenden Gesetzgebung zur Harmonisierung der EU, sofern die Installation, Wartung und Verwendung der Anwendung seinem Verwendungszweck entsprechend gemäß den geltenden Installationsstandards und der Vorgaben des Herstellers erfolgt.

2014/35/UE: Low Voltage Directive 2014/30/UE: Electromagnetic Compatibility Directive
2011/65/UE: RoHS2 Directive

Es besteht Konformität mit der/den folgender/folgenden Norm/Normen oder Regelwerk/Regelwerken

IEC 61010-1:2010+AMD1:2016 CSV Ed 3.0 IEC 61000-6-2:2016 Ed 3.0
IEC 61000-6-4:2006+AMD1:2010 CSV Ed 2.1

Jahr der CE-Kennzeichnung:

2018



DECLARAÇÃO DA UE DE CONFORMIDADE

A presente declaração de conformidade é expedida sob a exclusiva responsabilidade da CIRCUTOR com morada em Vial Sant Jordi, s/n – 08232 Viladecavalls (Barcelona) Espanha

Produto:

Instrumentação digital

Série:

DCB-48, DCB-72

Marca:

CIRCUTOR

O objeto da declaração está conforme a legislação de harmonização pertinente na UE, sempre que seja instalado, mantido e utilizado na aplicação para a qual foi fabricado, de acordo com as normas de instalação aplicáveis e as instruções do fabricante.

2014/35/UE: Low Voltage Directive 2014/30/UE: Electromagnetic Compatibility Directive
2011/65/UE: RoHS2 Directive

Está em conformidade com a(s) seguinte(s) norma(s) ou outro(s) documento(s) normativo(s):

IEC 61010-1:2010+AMD1:2016 CSV Ed 3.0 IEC 61000-6-2:2016 Ed 3.0
IEC 61000-6-4:2006+AMD1:2010 CSV Ed 2.1

Ano de marcação "CE":

2018



DICHIARAZIONE DI CONFORMITÀ UE

La presente dichiarazione di conformità viene rilasciata sotto la responsabilità esclusiva di CIRCUTOR, con sede in Vial Sant Jordi, s/n – 08232 Viladecavalls (Barcelona) Spagna

prodotto:

Strumentazione digitale

Serie:

DCB-48, DCB-72

MARCHIO:

CIRCUTOR

L'oggetto della dichiarazione è conforme alla pertinente normativa di armonizzazione dell'Unione Europea, a condizione che venga installato, mantenuto e utilizzato nell'ambito dell'applicazione per cui è stato prodotto, secondo le norme di installazione applicabili e le istruzioni del produttore.

2014/35/UE: Low Voltage Directive 2014/30/UE: Electromagnetic Compatibility Directive
2011/65/UE: RoHS2 Directive

È conforme alle seguenti normative o altri documenti normativi:

IEC 61010-1:2010+AMD1:2016 CSV Ed 3.0 IEC 61000-6-2:2016 Ed 3.0
IEC 61000-6-4:2006+AMD1:2010 CSV Ed 2.1

Anno di marcatura "CE":

2018



Viladecavalls (Spain), 16/05/2018
General Manager: Ferran Gil Torné



CIRCUTOR, SA – Vial Sant Jordi, s/n
08232 Viladecavalls (Barcelona) Spain
(+34) 937 452 900 – info@circutor.com



DEKLARACJA ZGODNOŚCI UE

Niniejsza deklaracja zgodności wydana na wyłączną odpowiedzialność firmy CIRCUTOR z siedzibą pod adresem: Vial Sant Jordi, s/n – 08232 Viladecavalls (Barcelona) Hiszpania

produkt:

Digital Instruments

Seria:

DCB-48, DCB-72

marka:

CIRCUTOR

Przedmiot deklaracji jest zgodny z odnośnymi wymaganiami prawodawstwa harmonizacyjnego w Unii Europejskiej pod warunkiem, że będzie instalowany, konserwowany i użytkowany zgodnie z przeznaczeniem, dla którego został wyprodukowany, zgodnie z mającymi zastosowanie normami dotyczącymi instalacji oraz instrukcjami producenta

2014/35/UE: Low Voltage Directive 2014/30/UE: Electromagnetic Compatibility Directive
2011/65/UE: RoHS2 Directive

Jest zgodny z następującą(y)mi normą(ami) lub innym(i) dokumentem(ami) normatywnym(i):

IEC 61010-1:2010+AMD1:2016 CSV Ed 3.0 IEC 61000-6-2:2016 Ed 3.0
IEC 61000-6-4:2006+AMD1:2010 CSV Ed 2.1

Rok oznakowania "CE":

2018

Viladecavalls (Spain), 16/05/2018
General Manager: Ferran Gil Torné



ANNEX A.- CONFIGURATION MENU

A.1.- DCB-48 Aac

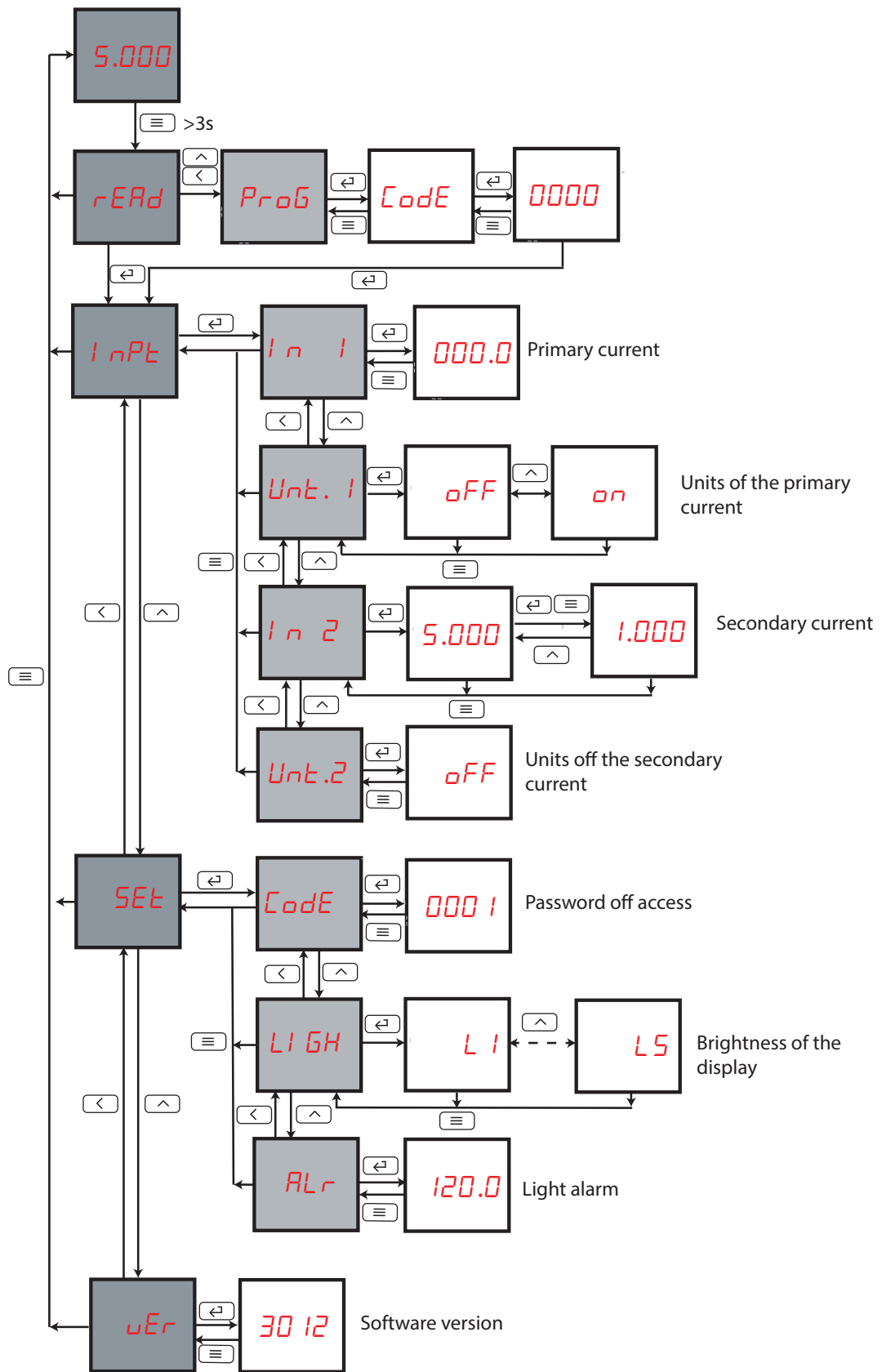

Figure 14: Configuration menu DCB-48 Aac

CIRCUTOR, SA

Vial Sant Jordi, s/n

08232 - Viladecavalls (Barcelona)

Tel.: (+34) 93 745 29 00 - Fax: (+34) 93 745 29 14

www.circutor.com central@circutor.com