

# Circuitor

AC Ammeter

**DCB-72 Aac**



## **INSTRUCTION MANUAL**

(M206B01-03-20A)







## SAFETY PRECAUTIONS

Follow the warnings described in this manual with the symbols shown below.

	<p><b>DANGER</b> Warns of a risk, which could result in personal injury or material damage.</p>
---	---

	<p><b>ATTENTION</b> Indicates that special attention should be paid to a specific point.</p>
---	--

If you must handle the unit for its installation, start-up or maintenance, the following should be taken into consideration:

	<p>Incorrect handling or installation of the unit may result in injury to personnel as well as damage to the unit. In particular, handling with voltages applied may result in electric shock, which may cause death or serious injury to personnel. Defective installation or maintenance may also lead to the risk of fire.</p> <p>Read the manual carefully prior to connecting the unit. Follow all installation and maintenance instructions throughout the unit's working life. Pay special attention to the installation standards of the National Electrical Code.</p>
---	--

	<p><b>Refer to the instruction manual before using the unit</b></p> <p>In this manual, if the instructions marked with this symbol are not respected or carried out correctly, it can result in injury or damage to the unit and / or installations.</p>
---	--

CIRCUTOR, SA reserves the right to modify features or the product manual without prior notification.

## DISCLAIMER

CIRCUTOR, SA reserves the right to make modifications to the device or the unit specifications set out in this instruction manual without prior notice.

CIRCUTOR, SA on its web site, supplies its customers with the latest versions of the device specifications and the most updated manuals.

[www.circutor.com](http://www.circutor.com)



	<p><b>CIRCUTOR</b>, recommends using the original cables and accessories that are supplied with the device.</p>
---	---

## CONTENTS

SAFETY PRECAUTIONS .....	3
DISCLAIMER .....	3
CONTENTS.....	4
REVISION LOG .....	5
SYMBOLS.....	5
1.- VERIFICATION UPON RECEPTION .....	6
2.- PRODUCT DESCRIPTION .....	6
3.- DEVICE INSTALLATION.....	7
3.1.- PRIOR RECOMMENDATIONS .....	7
3.2.- INSTALLATION .....	8
3.3.- DEVICE TERMINALS.....	9
3.4.- CONNECTION DIAGRAM.....	10
4.- OPERATION.....	11
4.1.- DISPLAY .....	11
4.2.- KEYBOARD FUNCTIONS.....	11
4.3.- RELAY OUTPUTS .....	12
4.4.- DISPLAY .....	12
5.- CONFIGURATION .....	13
5.1.- CONFIGURATION OF THE INPUT .....	15
5.1.1.- PRIMARY CURRENT.....	16
5.1.2.- UNITS OF THE PRIMARY CURRENT .....	16
5.1.3.- SECONDARY CURRENT .....	17
5.1.4.- UNITS OF THE SECONDARY CURRENT .....	17
5.1.5.- SAVE CONFIGURATION .....	17
5.2.- RELAY OUTPUT 1.....	18
5.2.1.- RELAY MODE.....	19
5.2.2.- RELAY PULSE DURATION.....	19
5.2.3.- ALARM PARAMETER .....	20
5.2.4.- CONNECTION DELAY.....	20
5.2.5.- ALARM VALUE .....	21
5.2.6.- HYSTERESIS.....	21
5.2.7.- SAVE CONFIGURATION .....	22
5.3.- RELAY OUTPUT 2 .....	22
5.4.- CONFIGURATION OF THE DISPLAY.....	23
5.4.1.- PASSWORD OFF ACCESS .....	23
5.4.2.- BRIGHTNESS OF THE DISPLAY.....	24
5.4.3.- LIGHT ALARM .....	24
5.4.4.- SAVE CONFIGURATION.....	25
5.5.- SOFTWARE VERSION.....	25
6.- TECHNICAL FEATURES.....	26
7.- MAINTENANCE AND TECHNICAL SERVICE.....	28
8.- GUARANTEE .....	28
9.- CE CERTIFICATE .....	29
ANNEX A.- CONFIGURATION MENU.....	32
A.1.- DCB-72 Aac .....	32
A.2.- DCB-72 Aac WITH RELAYS.....	33





## REVISION LOG

Table 1: Revision log.

Date	Revision	Description
06/18	M206B01-03-18A	Initial Version
12/18	M206B01-03-18B	Changes in the following sections: 3.3. - 3.4. - 4.3. - 9.- Annex A
04/19	M206B01-03-19A	Changes in the following sections: 2. - 5.1.3. - Annex A
11/20	M206B01-03-20A	Changes in the following sections: 3.3. - 4.3. - 5.2.5. - 5.2.6.

## SYMBOLS

Table 2: Symbols.

Symbol	Description
	In compliance with the relevant European directive.
	Device covered by European directive 2012/19/EC. At the end of its useful life, do not leave the unit in a household waste container. Follow local regulations on electronic equipment recycling.
	DC current
	AC current

**Note:** Devices images are for illustrative purposes only and may differ from the actual device.

## 1.- VERIFICATION UPON RECEPTION

Check the following points when you receive the device:

- The device meets the specifications described in your order.
- The device has not suffered any damage during transport.
- Perform an external visual inspection of the device prior to switching it on.
- Check that it has been delivered with the following:

- An installation guide,



If any problem is noticed upon reception, immediately contact the transport company and/or **CIRCUTOR's** after-sales service.

## 2.- PRODUCT DESCRIPTION

The **DCB-72 Aac** is a device designed to measure and display the current and frequency AC single-phase. The device has 2 programmable current scales: 1 A and 5 A.



The device features:

- **4 keys** that allow you to browse between the various screens and program the device.
- **LED display**, displays all parameters.
- **2 fully programmable relay outputs** (depending on the model).

Table 3:DCB-72 Aac list of models.

Model	Power Supply			Relays
	80 ... 270 V ~	80 ... 270 V ===	18 .. 36 V ===	
M22250	✓	✓	-	-
M22252	✓	✓	-	✓
M222500030000	-	-	✓	-
M222520030000	-	-	✓	✓

### 3.- DEVICE INSTALLATION

#### 3.1.- PRIOR RECOMMENDATIONS



In order to use the device safely, it is critical that individuals who handle it follow the safety measures set out in the standards of the country where it is being used, use the necessary personal protective equipment, and pay attention to the various warnings indicated in this instruction manual.

The **DCB-72 Aac** device must be installed by authorised and qualified staff.

The power supply plug must be disconnected and measuring systems switched off before handling, altering the connections or replacing the device. It is dangerous to handle the device while it is powered.

Also, it is critical to keep the cables in perfect condition in order to avoid accidents, personal injury and damage to installations.

The device's functionality is limited to the category of measuring voltage or specific current values.

The manufacturer of the device is not responsible for any damage resulting from failure by the user or installer to heed the warnings and/or recommendations set out in this manual, nor for damage resulting from the use of non-original products or accessories or those made by other manufacturers.

If an anomaly or malfunction is detected in the device, do not use it to take any measurements.



Disconnect the device from the power supply (device and measuring system power supply) before maintaining, repairing or handling the device's connections. Please contact the after-sales service if you suspect that there is an operational fault in the device.

### 3.2.- INSTALLATION



Terminals, opening covers or removing elements can expose parts that are hazardous to the touch while the device is powered. Do not use the device until it is fully installed.

The device should be installed inside an electric panel or enclosure, and panel-mounted.

To install it, take the following steps:

1.- Make a cut in the panel, according to the dimensions in **Figure 1**.

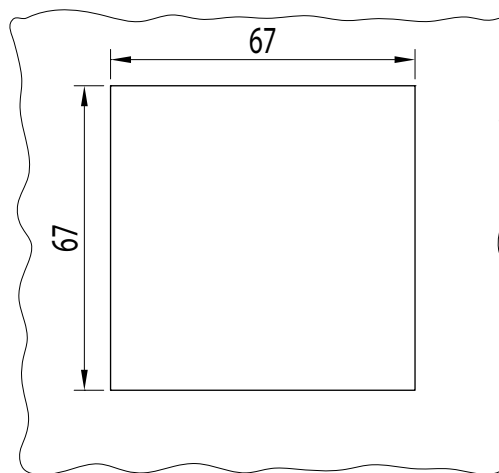

Figure 1: Cut in the panel.

2.- Remove the device's fixing clips (**Figure 2**).

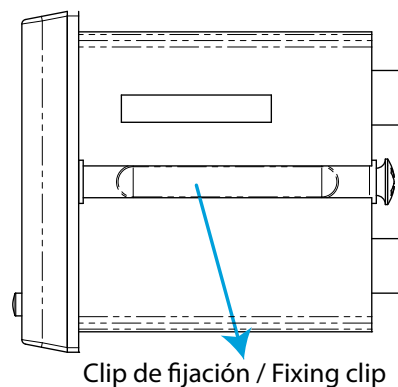

Figure 2: Installation.

3.- Insert the device into the cut in the panel.

4.- Fit the fixing clips until the device is fixed to the panel.

The device should be connected to a power circuit protected by a fuse with a maximum nominal current of **0.25 A**.



## 3.3.- DEVICE TERMINALS

## Version 1.0:

Table 4:List of terminals of the DCB-72 Aac (Version 1.0).

Device terminals	
1: L, Power supply.	28 <sup>(1)</sup> : Alarm output 1, relay (Common)
2: N, Power supply.	29 <sup>(1)</sup> : Alarm output 1, relay (NO)
4: Current measurement input	31 <sup>(1)</sup> : Alarm output 2, relay (Common)
5: Current measurement input	32 <sup>(1)</sup> : Alarm output 2, relay (NO)

## Version 2.0:

Table 5:List of terminals of the DCB-72 Aac (Version 2.0).

Device terminals	
1 : L, Power supply.	28 <sup>(1)</sup> : Alarm output 1, relay (NO)
2: N, Power supply.	31 <sup>(1)</sup> : Alarm output 1 and 2, relay (Common)
4: Current measurement input	
5: Current measurement input	32 <sup>(1)</sup> : Alarm output 2, relay (NO)

<sup>(1)</sup> Available for models: M22252 y M222520030000.

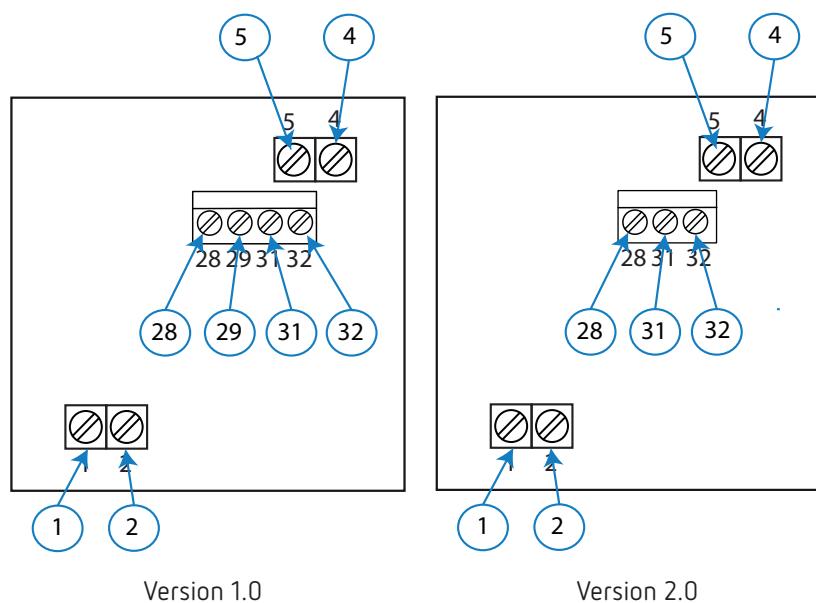

Figure 3:Terminals of the DCB-72 Aac.

**Note:** Before disconnecting the current measurement connection cables, make sure that you disconnect the transformer's primary cable and bridge the secondary.

## 3.4.- CONNECTION DIAGRAM

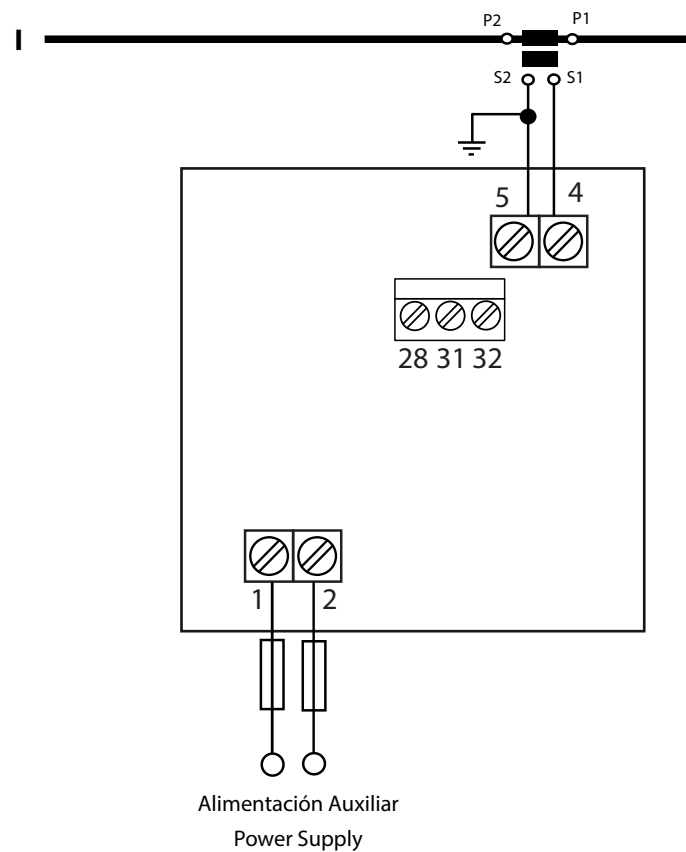

Figure 4: Current measurement DCB-72 Aac.

If the current being measured is higher than the nominal input current, **5A**, a current transformer should be connected to the device.

If more than one device is connected to the current transformer, it is necessary to connect them in series.

## 4.- OPERATION

### 4.1.- DISPLAY

The device features a 5-digit LED display, which is used to display the measured parameters and to configure these parameters

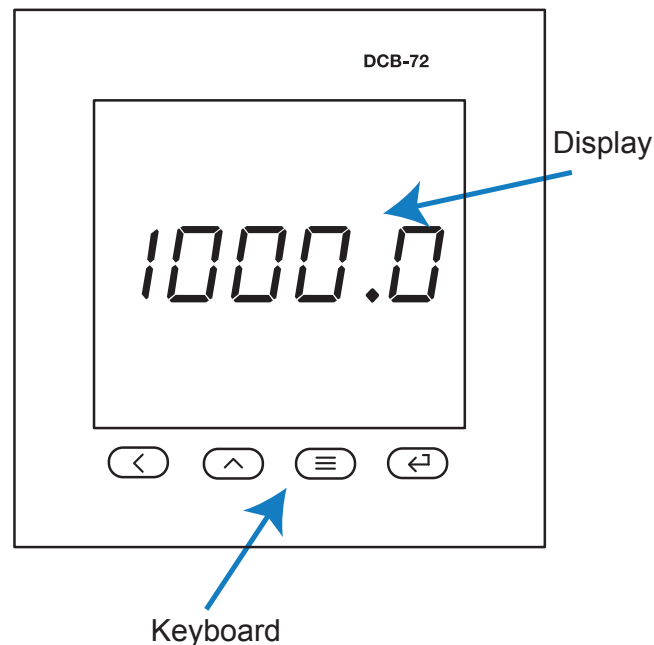





Figure 5: Display DCB-72.

### 4.2.- KEYBOARD FUNCTIONS

The DCB-72 Aac features 4 keys to display and configure the device, Figure 5.

Table 6: Keyboard functions.

Key	Keystroke
	Previous screen <b>In the configuration menu:</b> Scroll through the digits
	Next screen <b>In the configuration menu:</b> Increase the value of the digit
	<b>Long keystroke (&gt; 3s):</b> Enter in configuration menu
	<b>In the configuration menu:</b> Jump to the next level / Confirm an operation

4.3.- RELAY OUTPUTS





**Note:** only available for models: **M22252**, and **M222520030000**.

The device features two programmable relay outputs (terminals 28, 29, 31 and 32 in **Table 4**, terminals 28, 31 and 32, as shown in **Table 5**) that can be programmed as remote control signals or alarms in the setup menu ("**5.2.- RELAY OUTPUT 1**" and "**5.3.- RELAY OUTPUT 2**").

4.4.- DISPLAY

The **DCB-72 Aac** features 2 or 3 display screens, **Table 7**.

Table 7: Display menu.

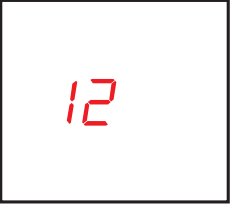
Display menu	
	
Current	
	
Frequency	
<p><i>Note: only available for models with relay outputs..</i></p>	
	
<p><b>Status of the relay outputs:</b>  <i>i</i>, status of the relay output 1: flashes when the relay is activated  <i>2</i>, status of the relay output 1: flashes when the relay is activated</p>	

If the current value measured by the device is higher than a % of the nominal value, the device can make the digits on the display start flashing, in the form of a light alarm. See "**5.4.3.- LIGHT ALARM**"

## 5.- CONFIGURATION

Press and hold the  key for more than 3 seconds to enter the configuration menu of the device. The configuration of the device is organized in different menus, **Figure 6**.

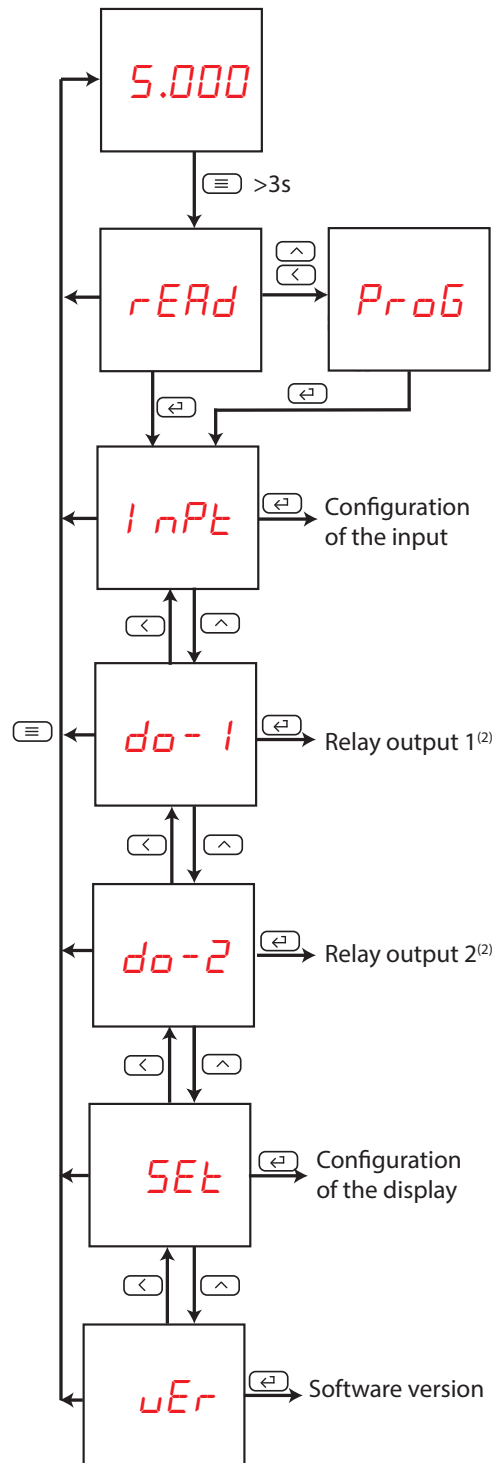





Figure 6: Configuration menu of the DCB-72 Aac.

<sup>(2)</sup> Only available for models with relay outputs.

From any screen of the configuration menus, if no key is pressed for 4 minutes, the device leaves the configuration menu and returns to the display screen.

**Note:** In "ANNEX A.- CONFIGURATION MENU" you can see the complete configuration menu.

On the *rEAd* screen, press the  key to access the configuration menu in the **display mode**, i.e., the configuration parameters cannot be modified.

On the *rEAd* screen, press the  or  keys to access the configuration menu in the **programming mode**, i.e., the configuration parameters can be modified.

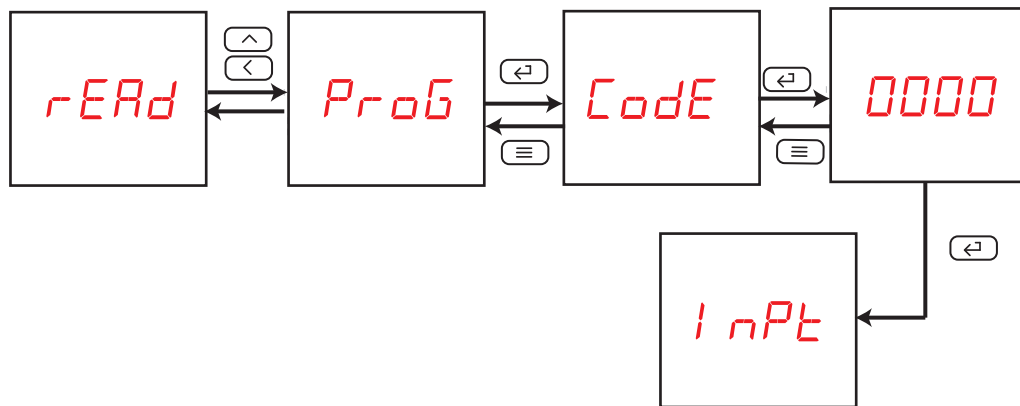

Figure 7: Access the configuration menu in the programming mode.

Before accessing the configuration menu, it is necessary to enter the access password.

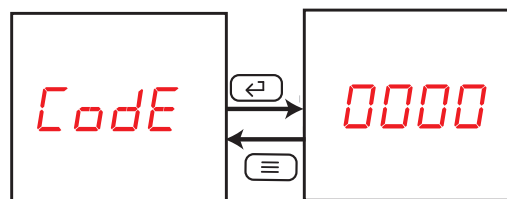



Figure 8: Access password.

Use the  key to modify the value of the flashing digit.  
When the desired value is shown on the screen, press the  key to skip the digit.

**Default password:** 0001

**Note:** The password can be modified, see "5.4.1.- PASSWORD OF ACCESS".

To validate the data, press the  key.

If the password entered is incorrect, the **Err** message will appear for a few seconds and the device will return to the password configuration screen, **Figure 8**.

## 5.1.- CONFIGURATION OF THE INPUT

Figure 9, shows the main screen of the input configuration menu, from which the primary current and secondary current are configured.

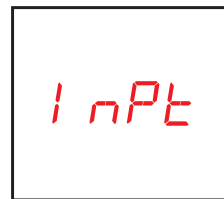

Figure 9: Input configuration menu, main screen.

Press the  key to open the configuration menu.

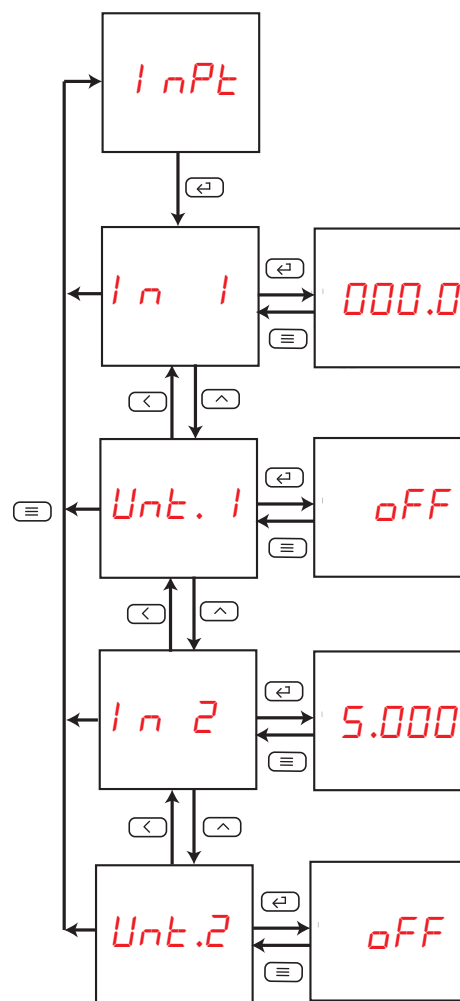
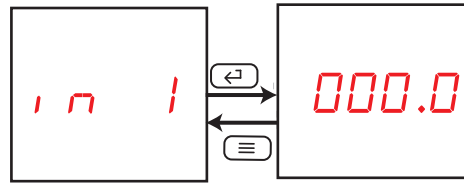





Figure 10: Input configuration menu.

### 5.1.1.- PRIMARY CURRENT

This screen is used to configure the value of the primary current.





Use the , key to modify the value of the flashing digit  
When the desired value is shown on the screen, press the  key to skip the digit.

When you reach the last digit and press the  key, you select the position of the decimal point. Use the  to modify the decimal point.

**Minimum configuration value:** 0.  
**Maximum configuration value:** 9999.

To validate the data, press the  key.

Use the  and  keys to browse the configuration screens of the menu.

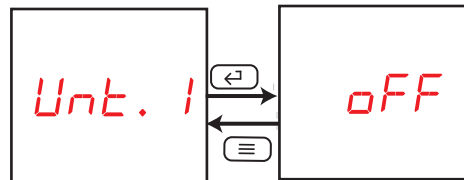

### 5.1.2.- UNITS OF THE PRIMARY CURRENT

This screen is used to configure the units of the primary current.



Use the ,key to browse the different options:  
**oFF**, the unit of the primary current is **A**.  
**o n**, the unit of the primary current is **kA**.

To validate the data, press the  key.

Use the  and  keys to browse the configuration screens of the menu.



### 5.1.3.- SECONDARY CURRENT

This screen is used to configure the value of the secondary current.

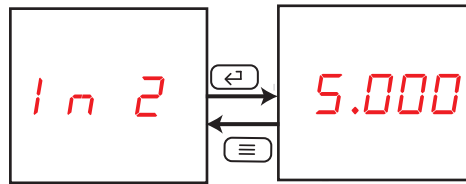

Use the and keys at the same time to configure the value.  
Use the ,key to browse the different options.

*5.000*, for the current scale of 0 ... 5 A.

*1.000*, for the current scale of 0 ... 1 A.

To validate the data, press the key.

Use the and keys to browse the configuration screens of the menu.

### 5.1.4.- UNITS OF THE SECONDARY CURRENT

**Note:** *This parameter cannot be modified.*

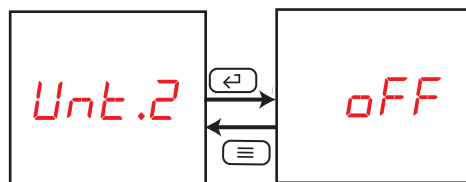

Use the and keys to browse the configuration screens of the menu.

### 5.1.5.- SAVE CONFIGURATION

To save the configuration of the device, press the key, until the main screen of the input configuration menu is opened, **Figure 9**.

Press the key again to show the validation screen.

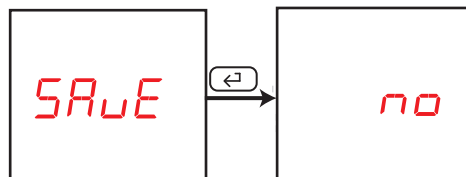

Use the ,key to browse the different options:

*no*, exit the configuration without saving the changed values.

*YES*, save the changed configuration values.

Press the key to validate the data and exit the configuration menu.

5.2.- RELAY OUTPUT 1

**Note:** Only available for models with relay outputs.

Figure 11, shows the main screen of the configuration menu of relay output 1.



Figure 11: Configuration menu of relay output 1, main screen.

Press the  key to open the setup menu.

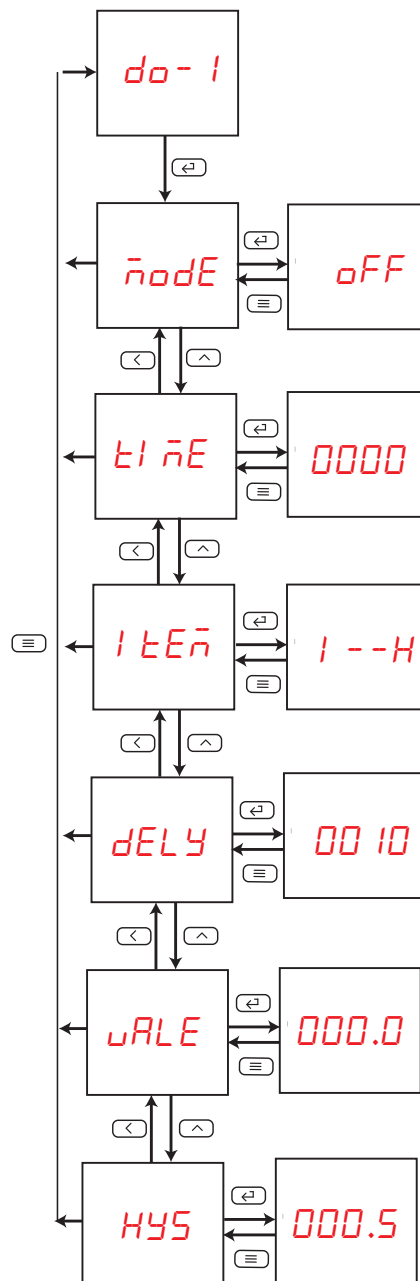
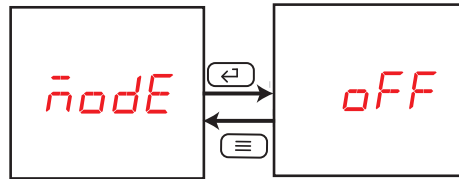

Figure 12: Configuration menu of relay output 1.

### 5.2.1.- RELAY MODE

This screen is used to configure the operating mode of relay 1.



Use the key to browse the different options:

**off**, relay output 1 is disabled.

**rem**, remote control output. **Note:** This option is only available in devices with communication.

**ALr**, alarm output.

To validate the data, press the key.

Use the and keys to browse the configuration screens of the menu.

### 5.2.2.- RELAY PULSE DURATION

The alarm relay can behave in 2 different ways:

1.- The relay is activated when the alarm is triggered and is deactivated when the alarm is deactivated.

2.- The relay is activated when the alarm is triggered and is deactivated after a programmed period of time, even though the alarm condition has not been cancelled.

This screen is used to configure the programmed time, i.e., the relay pulse duration.

To make the relay operate in mode **no. 1**, program the value to **0**.

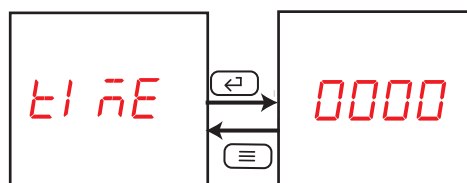

Use the key to modify the value of the flashing digit

When the desired value is shown on the screen, press the key to skip the digit.

**Minimum configuration value:** 0 x 0.1 s

**Maximum configuration value:** 9999 x 0.1 s

**Example:** Use program 0050 to configure a value of 5 s.

To validate the data, press the key.

Use the and keys to browse the configuration screens of the menu.

### 5.2.3.- ALARM PARAMETER

This screen is used to configure the parameter that will be used to activate the alarm.

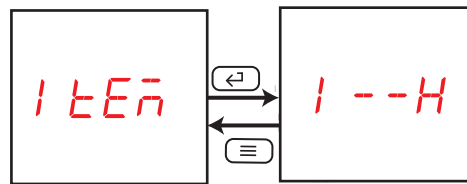

Use the  $\wedge$  key to browse the different options:

$F--H$ , Active alarm when the frequency is higher than the alarm value.

$I--H$ , Active alarm when the current is higher than the alarm value.

$F--L$ , Active alarm when the frequency is less than the alarm value.

$I--L$ , Active alarm when the current is less than the alarm value.

To validate the data, press the  $\leftarrow$  key.

Use the  $\leftarrow$  and  $\wedge$  keys to browse the configuration screens of the menu.

### 5.2.4.- CONNECTION DELAY

This screen is used to configure the alarm connection delay.

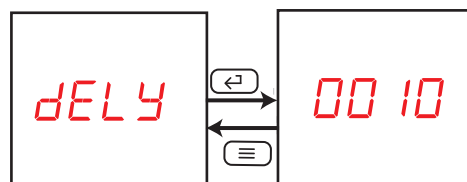

Use the  $\wedge$  key to modify the value of the flashing digit

When the desired value is shown on the screen, press the  $\leftarrow$  key to skip the digit.

**Minimum configuration value:** 0 x 0.1 s

**Maximum configuration value:** 9999 x 0.1 s

**Example:** Use program 0050 to configure a value of 5 s.

To validate the data, press the  $\leftarrow$  key.

Use the  $\leftarrow$  and  $\wedge$  keys to browse the configuration screens of the menu.

### 5.2.5.- ALARM VALUE

The value after which the alarm will be activated is configured on this screen. This value must be entered with reference to the value of the secondary current.

**Example:** In an installation where it has been programmed:

Primary current : **40.00 A**

Units of the primary current: **OFF (A)**

Secondary current: **5.000 A**

If you want to activate the alarm at a value of **7A**, the value to be programmed in this screen is:  $(5 \text{ A} \times 7 \text{ A}) / 40\text{A} = 0.875 \text{ A}$

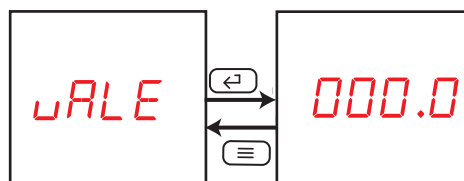



Use the , key to modify the value of the flashing digit

When the desired value is shown on the screen, press the  key to skip the digit.

**Minimum configuration value:** 0.000

**Maximum configuration value:** 9.999

To validate the data, press the  key.

Use the  and  keys to browse the configuration screens of the menu.

### 5.2.6.- HYSTERESIS

This screen is used to configure the hysteresis value, i.e., the difference between the alarm connection and disconnection value.

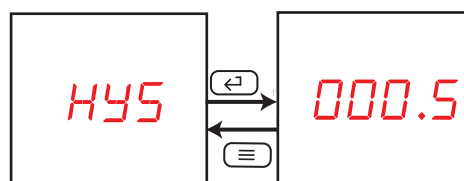



Use the , key to modify the value of the flashing digit

When the desired value is shown on the screen, press the  key to skip the digit.

**Minimum configuration value:** 0 A

**Maximum configuration value:** 9999 A

To validate the data, press the  key.

Use the  and  keys to browse the configuration screens of the menu.

### 5.2.7.- SAVE CONFIGURATION

To save the configuration of the device, press the  key until the main screen of the relay output 1 configuration menu is opened, **Figure 11**.

Press the  key again to show the validation screen.

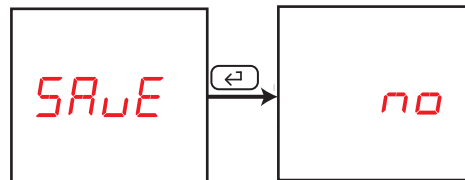

Use the  key to browse the different options:

**no**, exit the configuration without saving the changed values.

**YES**, save the changed configuration values.

Press the  key to validate the data and exit the configuration menu.

### 5.3.- RELAY OUTPUT 2

**Note:** Only available for models with relay outputs.

**Figure 13**, shows the main screen of the configuration menu of relay output 2.



Figure 13: Configuration menu of relay output 2, main screen.

The configuration is the same as for alarm relay 1, see "5.2.- RELAY OUTPUT 1".

## 5.4.- CONFIGURATION OF THE DISPLAY

Figure 14, shows the main screen of the configuration menu of the display.

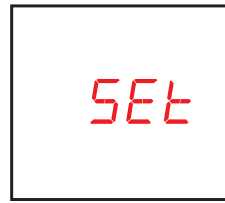

Figure 14: Configuration menu of the display, main screen.

Press the  key to open the configuration menu.

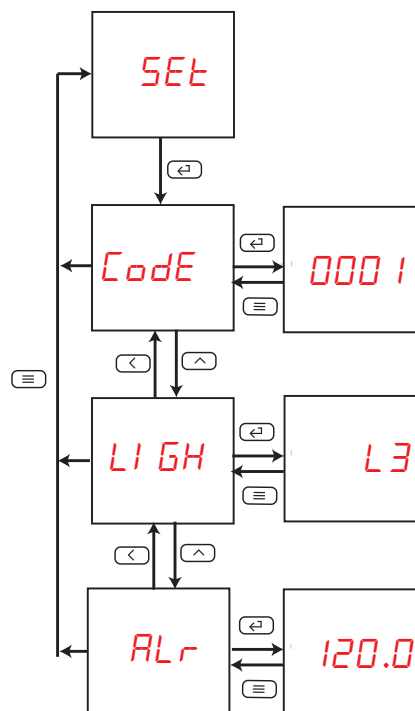
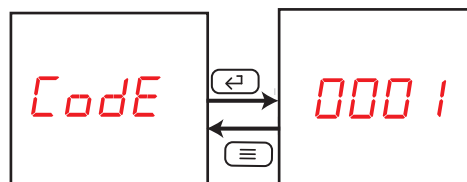



Figure 15: Configuration menu of the display.

### 5.4.1.- PASSWORD OFF ACCESS



This screen is used to configure the value of the password used to access the configuration menu in the **programming mode**.



Use the , key to modify the value of the flashing digit  
When the desired value is shown on the screen, press the  key to skip the digit.

**Minimum configuration value:** 0  
**Maximum configuration value:** 9999

To validate the data, press the  key.

Use the  and  keys to browse the configuration screens of the menu.

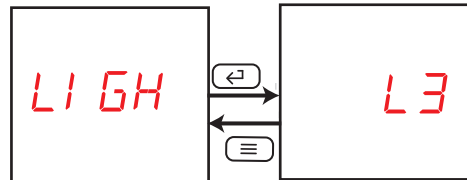

#### 5.4.2.- BRIGHTNESS OF THE DISPLAY

The brightness of the display is configured on this screen.



Use the , key to browse the different options: the display has 5 brightness levels, from *L 1* to *L 5*.

To validate the data, press the  key.

Use the  and  keys to browse the configuration screens of the menu.

#### 5.4.3.- LIGHT ALARM

If the current value measured by the device is higher than a % of the nominal value, the device can make the digits on the display start flashing, in the form of a light alarm.

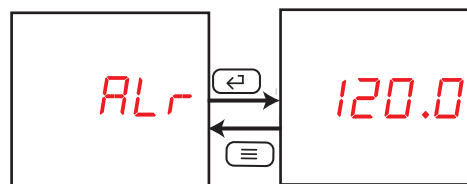

Use the , key to modify the value of the flashing digit.



When the desired value is shown on the screen, press the  key to skip the digit.

**Minimum configuration value:** 50.0%

**Maximum configuration value:** 120.0%

**Note:** If the a value of *0* is programmed, the light alarm will be deactivated.

To validate the data, press the  key.

Use the  and  keys to browse the configuration screens of the menu.



#### 5.4.4.- SAVE CONFIGURATION

To save the configuration of the device, press the  key until the main screen of the configuration menu of the display is opened, **Figure 14**.

Press the  key again to show the validation screen.

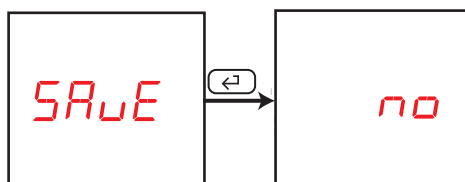

Use the  key to browse the different options:

*no*, exit the configuration without saving the changed values.

*YES*, save the changed configuration values.

Press the  key to validate the data and exit the configuration menu.

#### 5.5.- SOFTWARE VERSION

The software version of the device is shown in the **display mode**.

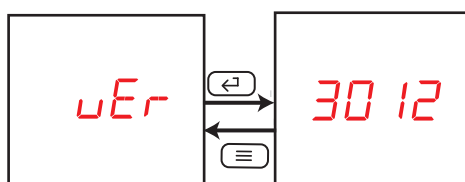

## 6.- TECHNICAL FEATURES

AC Power supply <sup>(3)</sup>		
Rated voltage	80 ... 270 V ~	
Frequency	50 / 60 Hz	
Consumption	Without relays	1.2 ... 3.5 VA
	With relays	1.8 ... 4 VA
Installation category	CAT III 300 V	

DC Power supply <sup>(3)</sup>		
Rated voltage	80 ... 270 V ===	18 ... 36 V ===
Consumption	Without relays	0.6 ... 0.7 W
	With relays	1.1 ... 1.2 W
Installation category	CAT III 300 V	

Current measurement circuit	
Nominal current (I <sub>n</sub> )	1 A ~ / 5 A ~
Frequency measurement margin	45 ... 65 Hz
Overload	1.2 I <sub>n</sub> continuous, 10 I <sub>n</sub> Instantaneous (5s)
Consumption	< 0.2 VA
Impedance	< 20 mΩ
Installation category	CAT III 300V

Measurement accuracy	
Current measurement	0.5%

Relays outputs <sup>(3)</sup>	
Quantity	2
Max. voltage open contacts	277 V~
Maximum current	5 A
Maximum switching power	1250 VA
Electrical life (250 V~ / 5A)	1x10 <sup>5</sup>
Mechanical life	5x10 <sup>6</sup>

<sup>(3)</sup> Depending on model:

Model	Power supply			Relays
	80 ... 270 V ~	80 ... 270 V ===	18 ... 36 V ===	
M22250	✓	✓	-	-
M22252	✓	✓	-	✓
M222500030000	-	-	✓	-
M222520030000	-	-	✓	✓

User interface	
Display	LED 5 digits
Keyboard	4 keys

Environmental features	
Operating temperature	-40°C ... +70°C
Storage temperature	-40°C ... +85°C
Relative humidity	≤ 95%
Maximum altitude	2000 m
Protection degree	Front: IP54, Rear case: IP20
Pollution degree	2

Mechanical features		
Dimensions	Figure 16 (mm)	
Weight	Without relays	With relays
	185 g.	215 g.
Surround	pc + abs	
Standards		
Electromagnetic compatibility (EMC) -- Part 4-2: Testing and measurement techniques - Electrostatic discharge immunity test.	IEC 61000-4-2	
Electromagnetic compatibility (EMC)- Part 4-3: Testing and measurement techniques- Radiated, radio-frequency, electromagnetic field immunity test	IEC 61000-4-3	
Electromagnetic compatibility (EMC) - Part 4-4: Testing and measurement techniques - Electrical fast transient/burst immunity test	IEC 61000-4-4	
Electromagnetic compatibility (EMC) - Part 4-5: Testing and measurement techniques - Surge immunity test	IEC 61000-4-5	
Electromagnetic compatibility (EMC) - Part 4-6: Testing and measurement techniques - Immunity to conducted disturbances, induced by radio-frequency fields	IEC 61000-4-6	
Electromagnetic compatibility (EMC) -- Part 4-8: Testing and measurement techniques - Power frequency magnetic field immunity test	IEC 61000-4-8	
Electromagnetic compatibility (EMC) -- Part 4-11: Testing and measurement techniques - Voltage dips, short interruptions and voltage variations immunity tests	IEC 61000-4-11	
Safety requirements for electrical equipment for measurement, control and laboratory use -- Part 1: General requirements	IEC 61010-1	

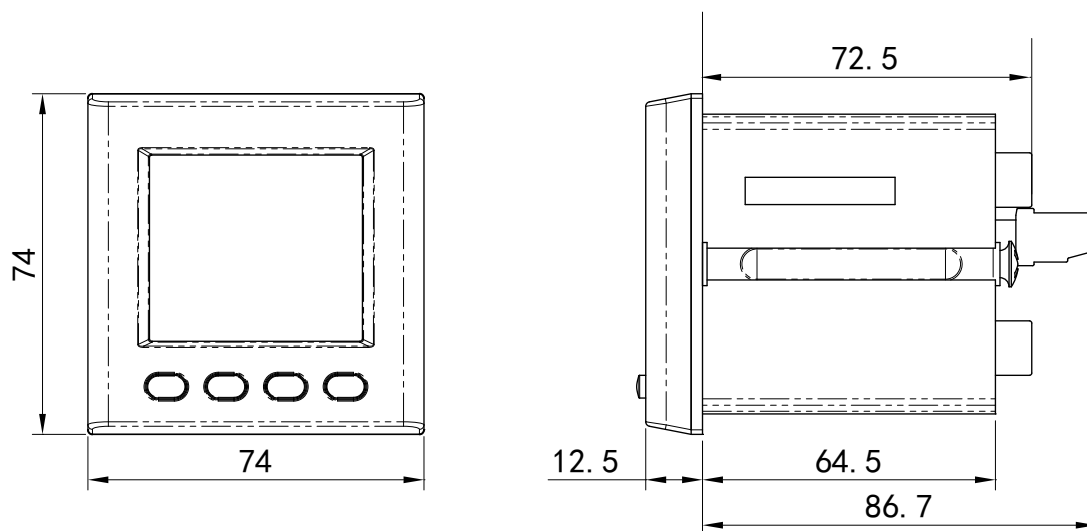

Figure 16: Dimensions of the DCB-72 Aac.

## 7.- MAINTENANCE AND TECHNICAL SERVICE

In the case of any query in relation to device operation or malfunction, please contact the **CIRCUTOR SA** Technical Support Service.

### Technical Assistance Service

Vial Sant Jordi, s/n, 08232 - Viladecavalls (Barcelona)

Tel: 902 449 459 ( España) / +34 937 452 919 (outside of Spain)

email: sat@circutor.com

## 8.- GUARANTEE

**CIRCUTOR** guarantees its products against any manufacturing defect for two years after the delivery of the units.

**CIRCUTOR** will repair or replace any defective factory product returned during the guarantee period.



- No returns will be accepted and no unit will be repaired or replaced if it is not accompanied by a report indicating the defect detected or the reason for the return.
- The guarantee will be void if the units has been improperly used or the storage, installation and maintenance instructions listed in this manual have not been followed. "Improper usage" is defined as any operating or storage condition contrary to the national electrical code or that surpasses the limits indicated in the technical and environmental features of this manual.
- **CIRCUTOR** accepts no liability due to the possible damage to the unit or other parts of the installation, nor will it cover any possible sanctions derived from a possible failure, improper installation or "improper usage" of the unit. Consequently, this guarantee does not apply to failures occurring in the following cases:
  - Overvoltages and/or electrical disturbances in the supply;
  - Water, if the product does not have the appropriate IP classification;
  - Poor ventilation and/or excessive temperatures;
  - Improper installation and/or lack of maintenance;
  - Buyer repairs or modifications without the manufacturer's authorisation.

## 9.- CE CERTIFICATE



### DECLARACIÓN UE DE CONFORMIDAD

La presente declaración de conformidad se expide bajo la exclusiva responsabilidad de CIRCUTOR con dirección en Vial Sant Jordi, s/n – 08232 Viladecavalls (Barcelona) España

Producto:

Instrumentación digital

Serie:

DCB-48, DCB-72

Marca:

CIRCUTOR

El objeto de la declaración es conforme con la legislación de armonización pertinente en la UE, siempre que sea instalado, mantenido y usado en la aplicación para la que ha sido fabricado, de acuerdo con las normas de instalación aplicables y las instrucciones del fabricante

2014/35/UE: Low Voltage Directive 2014/30/UE: Electromagnetic Compatibility Directive  
2011/65/UE: RoHS2 Directive

Está en conformidad con la(s) siguiente(s) norma(s) u otro(s) documento(s) normativos(s):

IEC 61010-1:2010+AMD1:2016 CSV Ed 3.0 IEC 61000-6-2:2016 Ed 3.0  
IEC 61000-6-4:2006+AMD1:2010 CSV Ed 2.1

Año de marcado "CE":

2018



### EU DECLARATION OF CONFORMITY

This declaration of conformity is issued under the sole responsibility of CIRCUTOR with registered address at Vial Sant Jordi, s/n – 08232 Viladecavalls (Barcelona) Spain

Product:

Digital Instruments

Series:

DCB-48, DCB-72

Brand:

CIRCUTOR

The object of the declaration is in conformity with the relevant EU harmonisation legislation, provided that it is installed, maintained and used for the application for which it was manufactured, in accordance with the applicable installation standards and the manufacturer's instructions

2014/35/UE: Low Voltage Directive 2014/30/UE: Electromagnetic Compatibility Directive  
2011/65/UE: RoHS2 Directive

It is in conformity with the following standard(s) or other regulatory document(s):

IEC 61010-1:2010+AMD1:2016 CSV Ed 3.0 IEC 61000-6-2:2016 Ed 3.0  
IEC 61000-6-4:2006+AMD1:2010 CSV Ed 2.1

Year of CE mark:

2018



### DECLARATION UE DE CONFORMITÉ

La présente déclaration de conformité est délivrée sous la responsabilité exclusive de CIRCUTOR dont l'adresse postale est Vial Sant Jordi, s/n – 08232 Viladecavalls (Barcelona) Espagne

Produit:

Instrumentation numérique

Série:

DCB-48, DCB-72

Marque:

CIRCUTOR

L'objet de la déclaration est conforme à la législation d'harmonisation pertinente dans l'UE, à condition d'avoir été installé, entretenu et utilisé dans l'application pour laquelle il a été fabriqué, conformément aux normes d'installation applicables et aux instructions du fabricant

2014/35/UE: Low Voltage Directive 2014/30/UE: Electromagnetic Compatibility Directive  
2011/65/UE: RoHS2 Directive

Il est en conformité avec la(les) suivante (s) norme(s) ou autre(s) document(s) réglementaire (s):

IEC 61010-1:2010+AMD1:2016 CSV Ed 3.0 IEC 61000-6-2:2016 Ed 3.0  
IEC 61000-6-4:2006+AMD1:2010 CSV Ed 2.1

Année de marquage « CE »:

2018



Viladecavalls (Spain), 16/05/2018  
General Manager: Ferran Gil Torné



**KONFORMITÄTSERKLÄRUNG UE**

Vorliegende Konformitätserklärung wird unter alleiniger Verantwortung von CIRCUTOR mit der Anschrift, Vial Sant Jordi, s/n – 08232 Viladecavalls (Barcelona) Spanien, ausgestellt

Produkt:

Digitale Messgeräte

Serie:

DCB-48, DCB-72

Marke:

CIRCUTOR

Der Gegenstand der Konformitätserklärung ist konform mit der geltenden Gesetzgebung zur Harmonisierung der EU, sofern die Installation, Wartung und Verwendung der Anwendung seinem Verwendungszweck entsprechend gemäß den geltenden Installationsstandards und der Vorgaben des Herstellers erfolgt.

2014/35/UE: Low Voltage Directive 2014/30/UE: Electromagnetic Compatibility Directive  
2011/65/UE: RoHS2 Directive

Es besteht Konformität mit der/den folgenden/folgenden Norm/Normen oder Regelwerk/Regelwerken

IEC 61010-1:2010+AMD1:2016 CSV Ed 3.0 IEC 61000-6-2:2016 Ed 3.0  
IEC 61000-6-4:2006+AMD1:2010 CSV Ed 2.1

Jahr der CE-Kennzeichnung:

2018



**DECLARAÇÃO DA UE DE CONFORMIDADE**

A presente declaração de conformidade é expedida sob a exclusiva responsabilidade da CIRCUTOR com morada em Vial Sant Jordi, s/n – 08232 Viladecavalls (Barcelona) Espanha

Produto:

Instrumentação digital

Série:

DCB-48, DCB-72

Marca:

CIRCUTOR

O objeto da declaração está conforme a legislação de harmonização pertinente na UE, sempre que seja instalado, mantido e utilizado na aplicação para a qual foi fabricado, de acordo com as normas de instalação aplicáveis e as instruções do fabricante.

2014/35/UE: Low Voltage Directive 2014/30/UE: Electromagnetic Compatibility Directive  
2011/65/UE: RoHS2 Directive

Está em conformidade com a(s) seguinte(s) norma(s) ou outro(s) documento(s) normativo(s):

IEC 61010-1:2010+AMD1:2016 CSV Ed 3.0 IEC 61000-6-2:2016 Ed 3.0  
IEC 61000-6-4:2006+AMD1:2010 CSV Ed 2.1

Ano de marcação "CE":

2018



**DICHIARAZIONE DI CONFORMITÀ UE**

La presente dichiarazione di conformità viene rilasciata sotto la responsabilità esclusiva di CIRCUTOR, con sede in Vial Sant Jordi, s/n – 08232 Viladecavalls (Barcelona) Spagna

prodotto:

Strumentazione digitale

Serie:

DCB-48, DCB-72

MARCHIO:

CIRCUTOR

L'oggetto della dichiarazione è conforme alla pertinente normativa di armonizzazione dell'Unione Europea, a condizione che venga installato, mantenuto e utilizzato nell'ambito dell'applicazione per cui è stato prodotto, secondo le norme di installazione applicabili e le istruzioni del produttore.

2014/35/UE: Low Voltage Directive 2014/30/UE: Electromagnetic Compatibility Directive  
2011/65/UE: RoHS2 Directive

È conforme alle seguenti normative o altri documenti normativi:

IEC 61010-1:2010+AMD1:2016 CSV Ed 3.0 IEC 61000-6-2:2016 Ed 3.0  
IEC 61000-6-4:2006+AMD1:2010 CSV Ed 2.1

Anno di marcatura "CE":

2018



Viladecavalls (Spain), 16/05/2018  
General Manager: Ferran Gil Torné



CIRCUTOR, SA – Vial Sant Jordi, s/n  
08232 Viladecavalls (Barcelona) Spain  
(+34) 937 452 900 – info@circutor.com



#### DEKLARACJA ZGODNOŚCI UE

Niniejsza deklaracja zgodności zostaje wydana na wyłączną odpowiedzialność firmy CIRCUTOR z siedzibą pod adresem: Vial Sant Jordi, s/n – 08232 Viladecavalls (Barcelona) Hiszpania

produkt:

Digital Instruments

Seria:

DCB-48, DCB-72

marka:

CIRCUTOR

Przedmiot deklaracji jest zgodny z odnośnymi wymaganiami prawodawstwa harmonizacyjnego w Unii Europejskiej pod warunkiem, że będzie instalowany, konserwowany i użytkowany zgodnie z przeznaczeniem, dla którego został wyprodukowany, zgodnie z mającymi zastosowanie normami dotyczącymi instalacji oraz instrukcjami producenta

2014/35/UE: Low Voltage Directive 2014/30/UE: Electromagnetic Compatibility Directive  
2011/65/UE: RoHS2 Directive

Jest zgodny z następującą(y)mi normą(ami) lub innym(i) dokumentem(ami) normatywnym(i):

IEC 61010-1:2010+AMD1:2016 CSV Ed 3.0 IEC 61000-6-2:2016 Ed 3.0  
IEC 61000-6-4:2006+AMD1:2010 CSV Ed 2.1

Rok oznakowania "CE":

2018



Viladecavalls (Spain), 16/05/2018  
General Manager: Ferran Gil Torné

ANNEX A.- CONFIGURATION MENU

A.1.- DCB-72 Aac

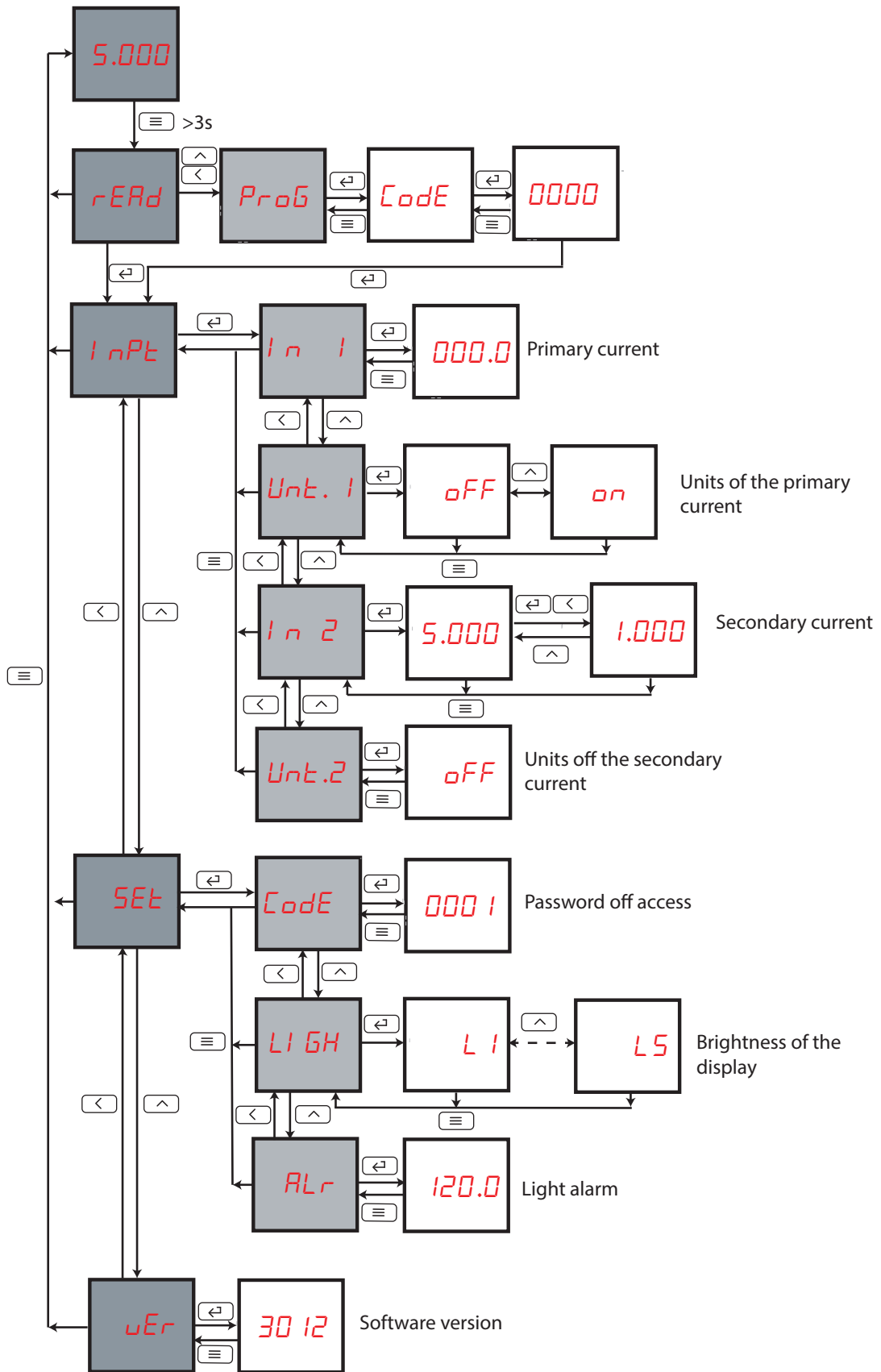

Figure 17: Configuration menu DCB-72 Aac



A.2.- DCB-72 Aac WITH RELAYS

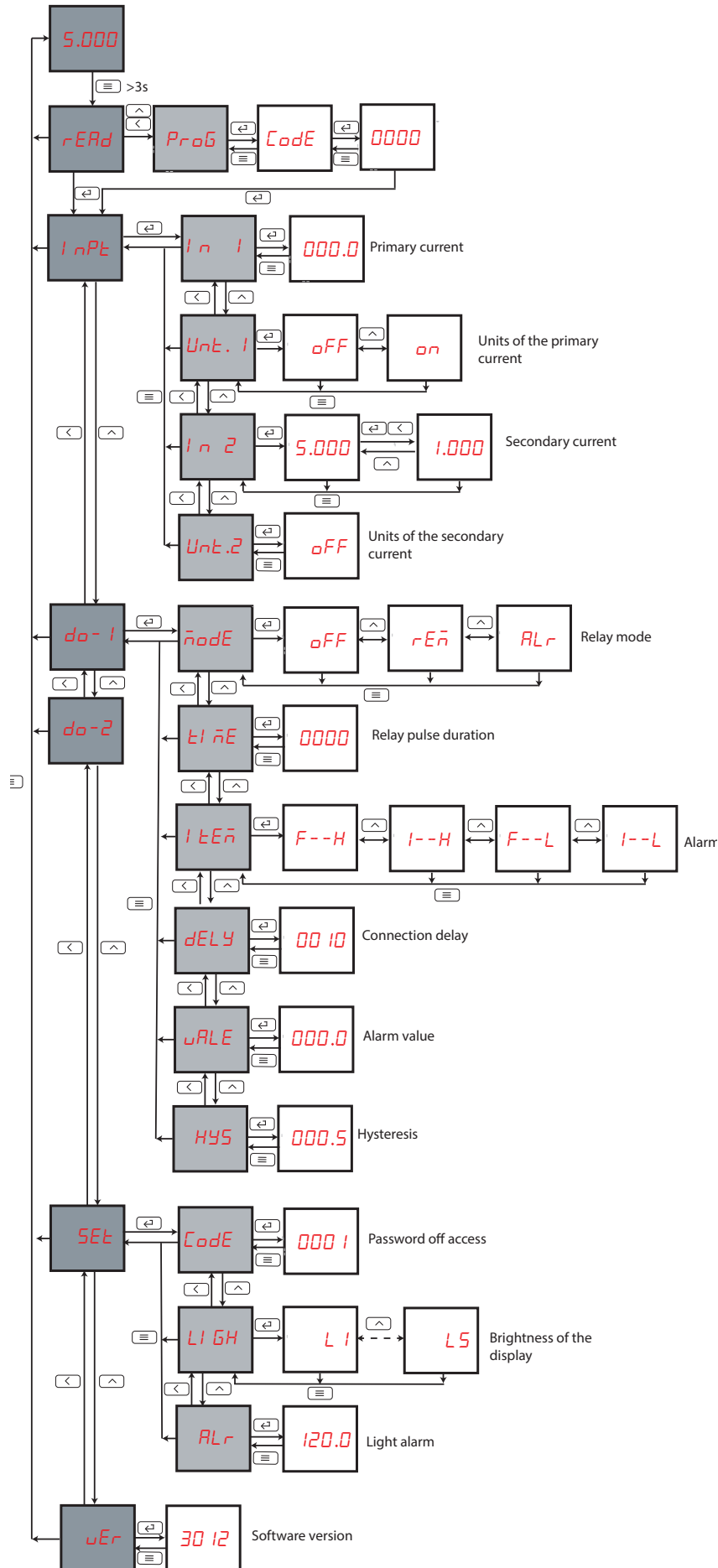

Figure 18: Configuration menu DCB-72 Aac (with relays)

**CIRCUTOR, SA**

Vial Sant Jordi, s/n

08232 -Viladecavalls (Barcelona)

Tel.: (+34) 93 745 29 00 - Fax: (+34) 93 745 29 14

[www.circutor.com](http://www.circutor.com) [central@circutor.com](mailto:central@circutor.com)