



Digalox DPM72-MPP

Instruction manual (Rev-2020-11)

Graphical panel meter with RGB backlight
for analogue signal 0/2 - 10 V and 0/4 - 20 mA

Package contents: Panel meter Digalox DPM72-MPP, mounting bracket,
5 jumpers, 2 instruction manuals (EN + DE)

1. Safety instructions

- Read instruction manual carefully before operating the device! Keep for later reference.
- Mounting and installation must be carried out by suitably qualified and competent persons only.
- **When working on the device hazardous voltages must not be connected to the device! The terminals J1-J12 are not isolated from the measuring circuit.**
- **The device must not be used as the only protective device or protective shutdown.**
- The device is not intended to protect persons or facilities against harm. Specific devices must be used to guarantee safety (protection relays, cut-off switches, etc.).
- When connecting switches to the terminals J1-J6, only switches must be used whose isolation voltage is at least twice the maximum occurring measurement voltage. For example, when measuring 30 V DC switches must be isolated for at least 60 V.
- Do not open the housing!
- Do not use the device in the presence of explosive or flammable substances!
- All cables carrying hazardous voltages must be secured with external separators.

2. Meaning of symbols



General warning sign
(Attention, observe the documentation!)



Warning of an electrical hazard

3. Intended use

- Measurement of current and voltage in the specified measuring ranges for process signals
- Indoor use non condensing, non corrosive.
- Panel mounting.
- In operation, supply the device preferably via screw terminals with 12 to 24 V AC/DC. If the device is supplied via USB in operation, USB supply voltage must be at least 5 V.
- Failure to comply with these instructions will void all guarantee and warranty.

4. Description

The measurement modes analogue signal 0/2 to 10 V and 0/4 to 20 mA DC are supported. The multi display with RGB backlight is able to display up to four parameters simultaneously. Thresholds can be associated with individual warning colours. The unit can be switched between measurement modes via an external switch. Minimum and maximum values are recorded and can be displayed and reset via jumper or an external switch. Measured values are recorded over a timespan of 36 seconds up to 14 days. The timebase as well as the display of the measuring history can be activated by an external switch. The measured values remain stored as long as the device is supplied with voltage.

The following parameters can be adjusted using the configuration software “Digalox Manager”: scale endpoint, scale caption, display style (pointer, tachometer, bar graph, and more), splash image, backlight colour, thresholds for alarm output, threshold warning colour (light, blink), hysteresis, and more. Recorded measurement values can be read and a continuous transmission of the actual measuring value can be enabled. Using the software, values can be viewed and exported as CSV. Depending on the model, measured values can be transmitted via USB, XBEE radio technology or RS485 Modbus interface. In addition, the devices feature a counting function with data retention. This enables operating-hours-counters or time-counters for exceeding and falling below threshold values, as well as single pulse counting.

Visit **www.digalox.com** to download the software “Digalox Manager”.

5. Product overview

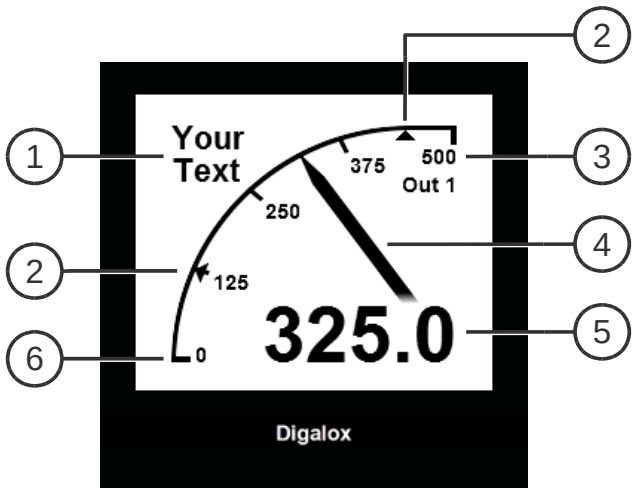
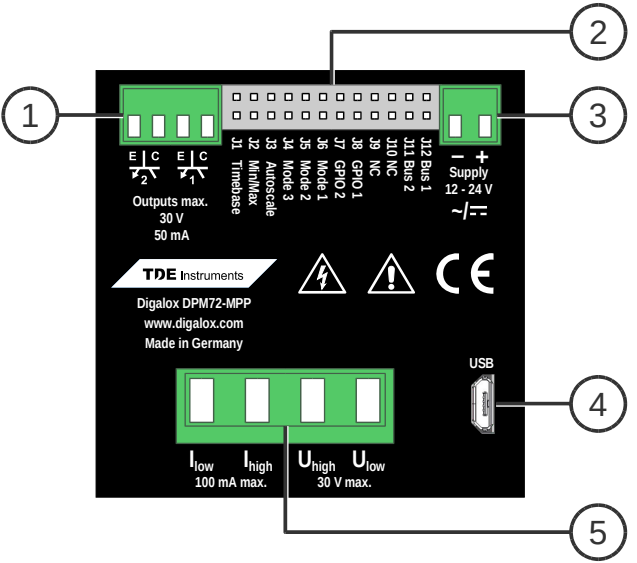
	<p>Front</p> <ol style="list-style-type: none"> 1 Unit or free text 2 Threshold values 3 Upper scale caption 4 Graphical measurement display 5 Digital measurement value 6 Lower scale caption
	<p>Back</p> <ol style="list-style-type: none"> 1 2 optocoupler switch outputs 2 Jumper pins J1–J12 for activating/switching of graphical historic data display, min/max display, auto-scaling, measurement mode 3 Supply voltage input 4 Interface (USB / XBEE / RS485) 5 Measurement inputs

6. Mounting

Carefully insert the device into the panel cut-out. Insert the mounting bracket from the back and push towards the panel until the device sits tight. Make sure the mounting bracket is snapped into the side of the housing. To ensure IP65 protection (dust and water jet) when mounting in a front panel, use optional gasket (separately available).

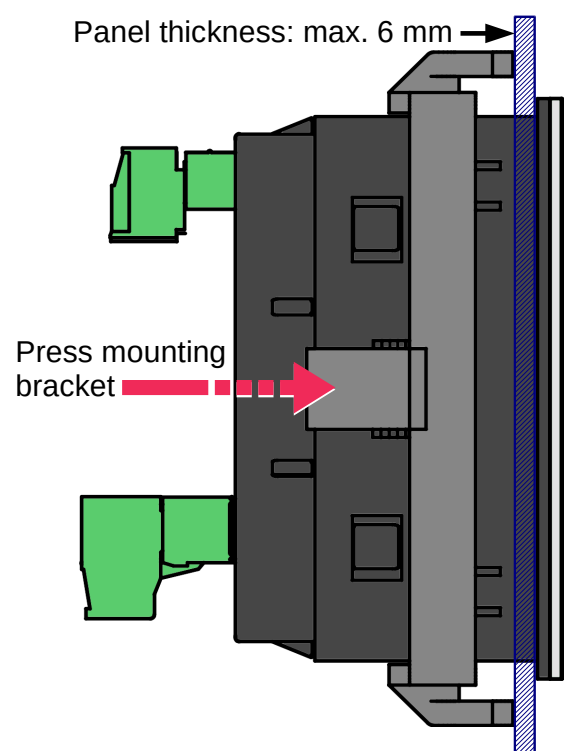

7. Electrical connections

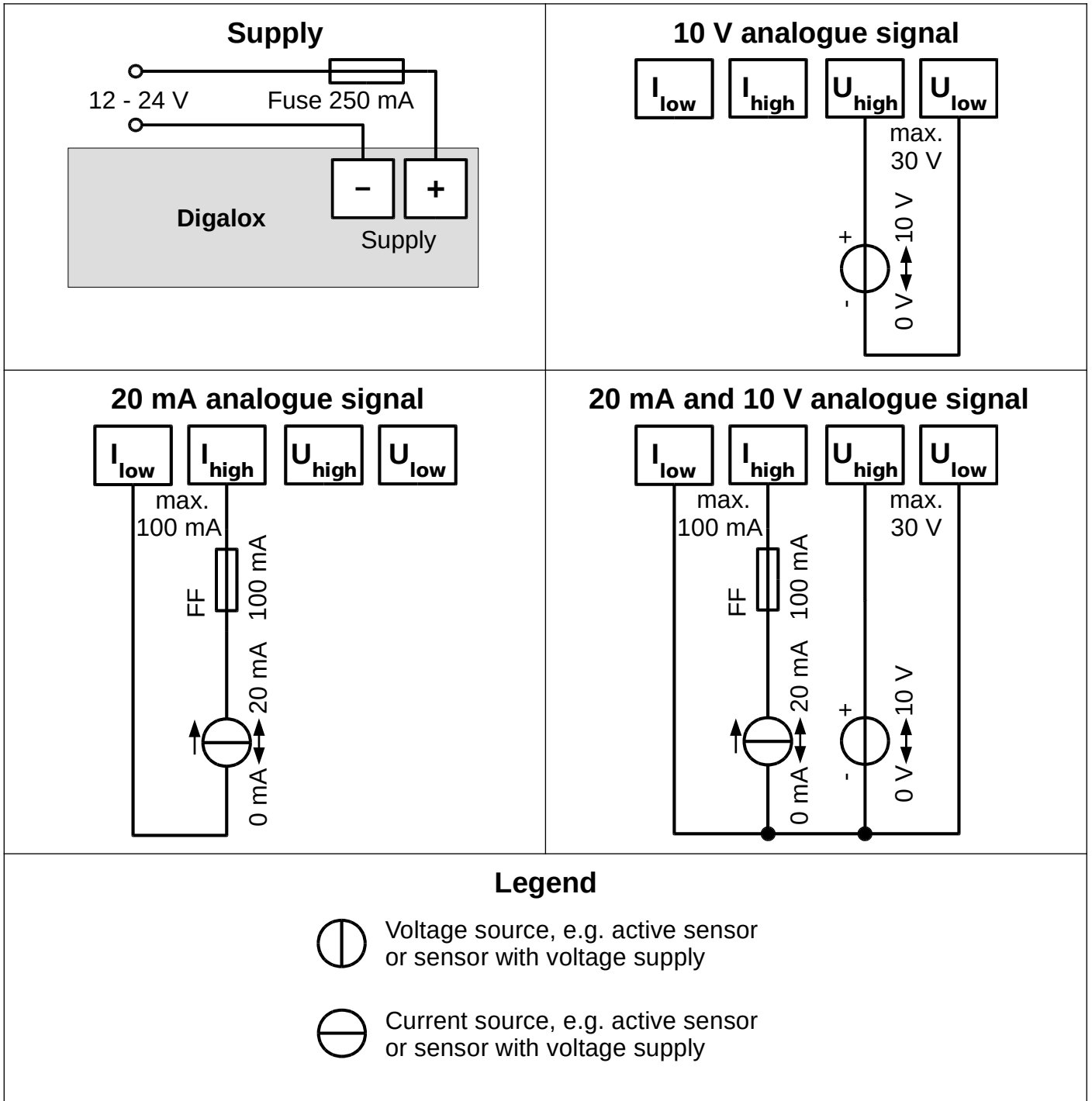

WARNING: The device may only be operated in one of the connection options shown above!

8. Configuration

Connect the device to a computer:



USB: Connect the device and the computer using a USB cable. The device driver is installed automatically if the computer is connected to the Internet.



XBEE: Insert the XBEE stick into the computer. The device driver is installed automatically if the computer is connected to the Internet. In order to reset the XBEE settings, short-circuit terminal J8.



RS485: Short-circuit terminal J8. Disconnect the device from the Modbus network and connect it to the computer using an RS485 USB adapter. After completing the configuration, open J8 again.

Start the "Digalox Manager" software and connect it to the device. Settings can then be made on the various tabs and saved in the device.

Please note that the measurement mode selected in "Digalox Manager" is displayed only until the power supply of the DPM72 is interrupted.



In further operation, the device always shows the first measurement mode or the one that is selected by the jumpers J4-J6 (see table "Measurement mode"),

in case of a multi display style additionally the following measuring modes.

Table measurement mode (factory preset, can be changed by software)

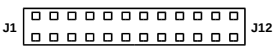
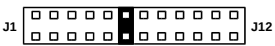
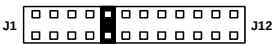
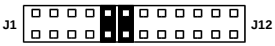
	Measurement mode	Display	Measurement mode selection
1	10 V DC scaled	10 V %	
2	2-10 V DC scaled	2-10 V %	
3	20 mA DC scaled	20 mA %	
4	4-20 mA DC scaled	4-20 mA %	

9. Other settings

The following functions can be activated independently during operation by short-circuiting connectors J1-J3, e.g. using a jumper or switch:

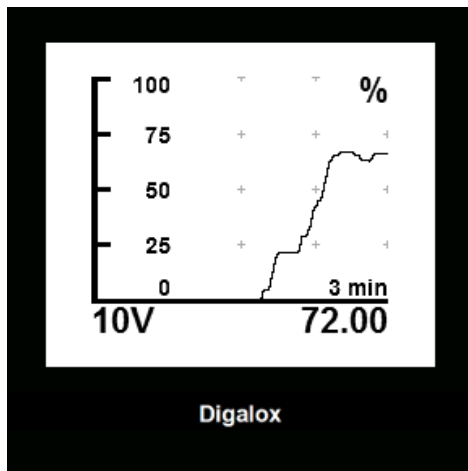

J1: Graphical historic data display

The unit displays the stored values within the set time base as a graphical trend. The time base can be set to days (7, 14), hours (1, 3, 6, 12, 24, 48, 72), minutes (3, 15, 30) or seconds (36).

The time base can be changed by alternately opening and closing J1 (interval < 2 sec). When first opening and closing J1 the current time base is displayed. For each subsequent opening and closing the time base changes to the next setting. In order to save the setting permanently, the software "Digalox Manager" has to be used.

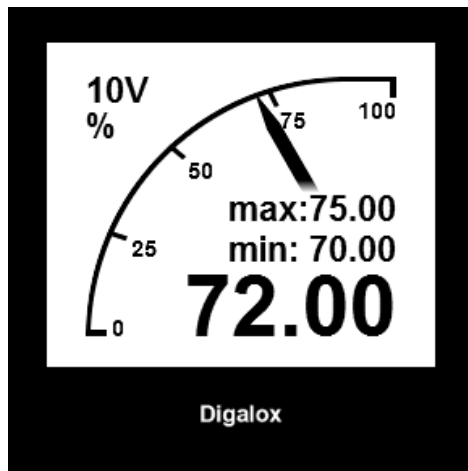

J2: Min-Max display

The display shows the maximum and minimum values recorded since the last reset. The values can be reset by opening and closing connection J2 shortly (interval < 2 sec). The display shows "Minmax reset".

J3: Auto-scaling

The device automatically changes the upper scale caption depending on the current measuring value between 10, 100 and the set upper scale caption.

10. Maintenance

Periodically check all external cable connections.

11. Cleaning

Observe the safety instructions before cleaning the device. Clean the device with a dry lint-free soft cloth. Do not use solvents.

12. Specification

	DPM72-MPP
Supply	12 - 24 V AC/DC $\pm 10\%$ (50/60 Hz $\pm 10\%$) or via USB (min. 5 V), galvanically isolated
Power consumption	Max. 2.4 W
Display	LCD graphic display 192 × 160 pixels, 16 grey levels with RGB backlight
Measuring range voltage	± 30 V DC, 20 V AC, 10 - 500 Hz
Accuracy voltage	± 0.5 % true RMS
Internal resistance voltage	102 k Ω
Measuring range ampere	20 mA AC/DC (max. 100 mA), 10 - 500 Hz
Accuracy ampere	$\pm 0,5$ % true RMS
Internal resistance ampere	6.2 Ω
Measuring value update	5 Hz (32 kHz sampling rate)
Recording of measurement	36 seconds to 14 days, 180 internal memory locations
Alarm outputs	2 optocoupler outputs max. 30 V DC, 50 mA
Permissible voltage between supply and measuring inputs	< 50 V AC, < 75 V DC
Connections (measuring inputs) - Wire gauge - Wire strip length - Pitch	0.2 - 3.3 mm ² (24 to 12 AWG) 7 - 8 mm 7.62 mm
Connections (supply, alarm outputs and RS485) - Wire gauge - Wire strip length - Pitch	0.13 - 1.3 mm ² (26 to 16 AWG) 6 - 7 mm 3.5 mm
Operating temperature	0 °C to +50 °C
Storage temperature	-20 °C to +70 °C
Operating altitude	0 to 2000 m above sea level
IP code	IP65 (front), IP00 (back)
Dimensions	72 mm × 72 mm × 58 mm
Panel cut-out	68 mm × 68 mm
Depth	55.3 mm (with plugs, cable direction rear facing) 72.6 mm (with antenna)
Net weight	148 g

13. Dimensions [mm]

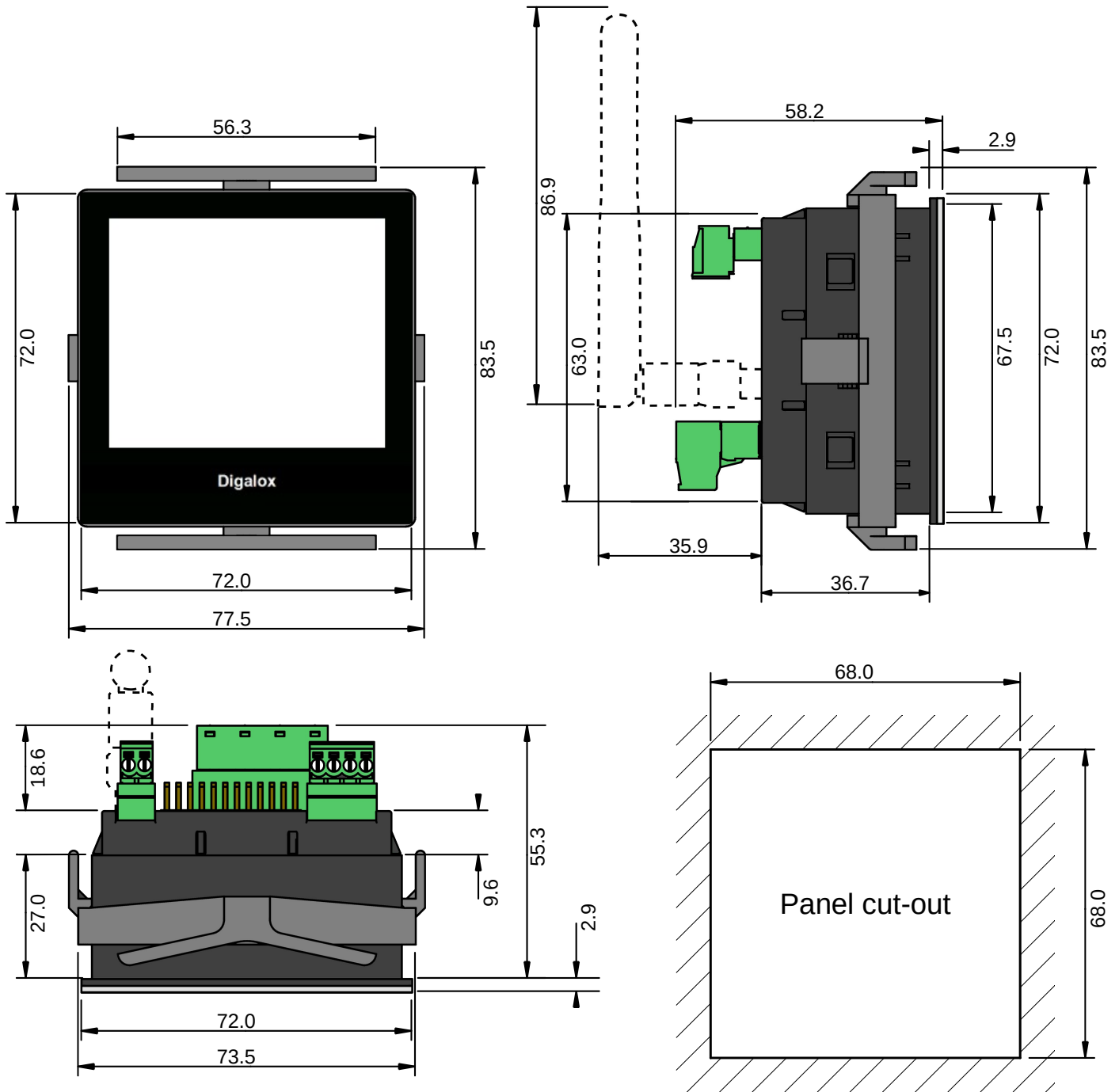

14. Available accessories

TDE Instruments Digalox DPM72 gasket EPDM/SBR

15. Contact information

TDE Instruments GmbH, Gewerbestraße 8, D-71144 Steinenbronn

Phone: +49 7157 20801

E-Mail: info@tde-instruments.de

Internet: www.tde-instruments.de, www.digalox.com